

ZOCCOLI DEI TUBI ELETTRONICI

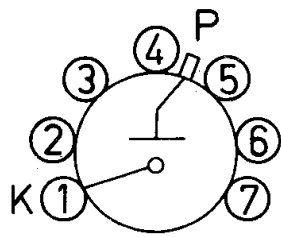

2AG

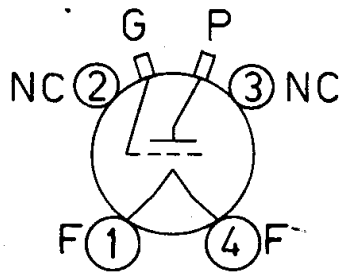

2D

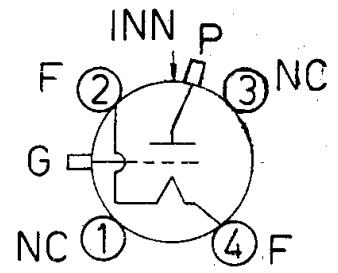

2N

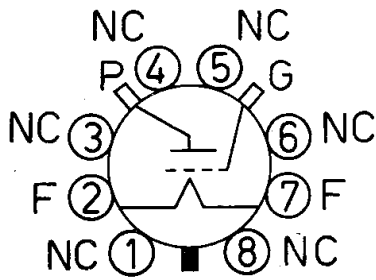

2T

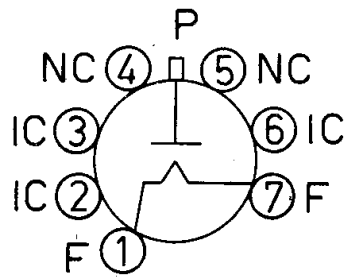

2Z

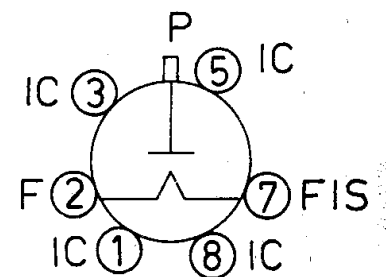

3C

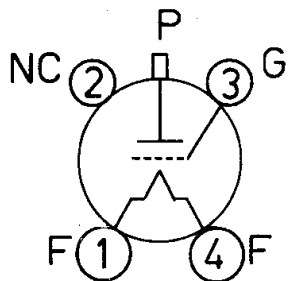

3G

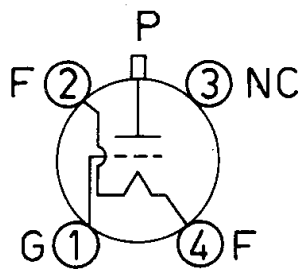

3N

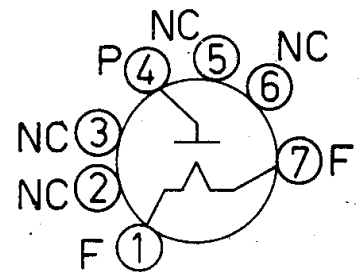

3T

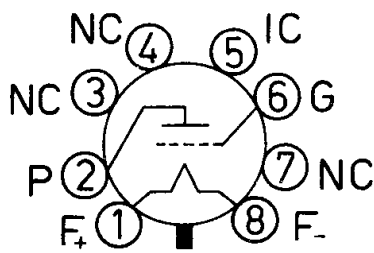

4AA

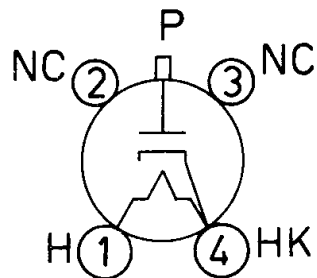

4AB

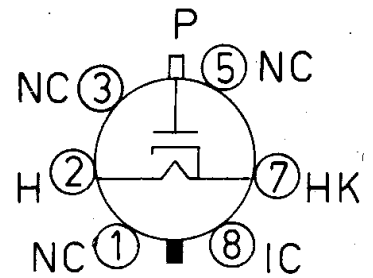

4AC

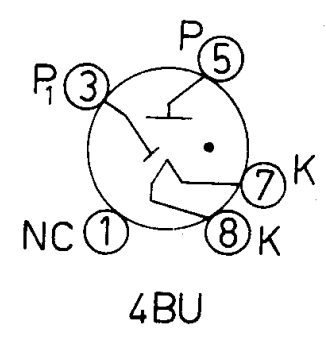
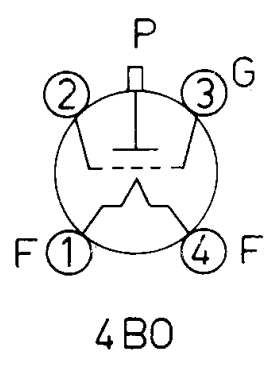
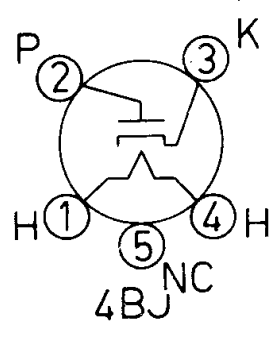
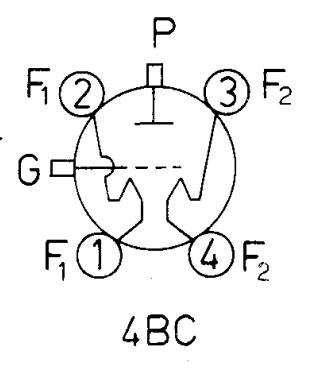
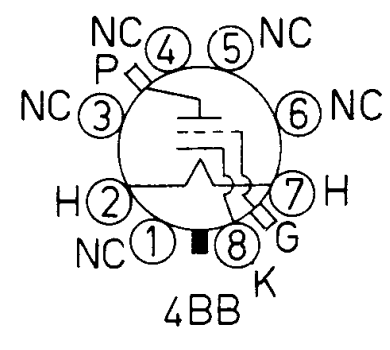
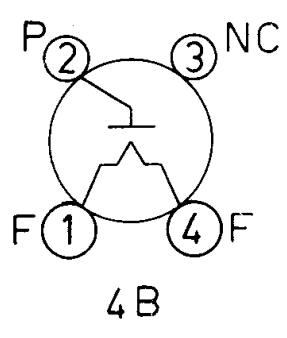
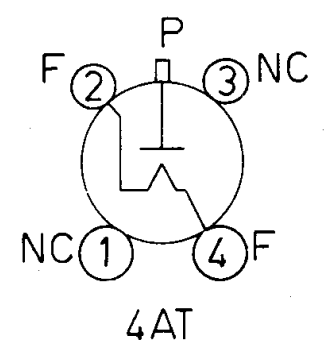
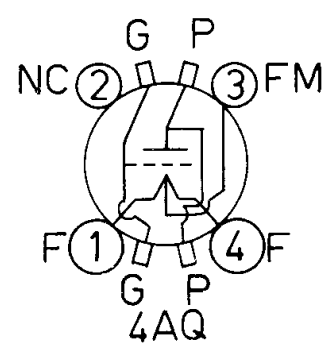
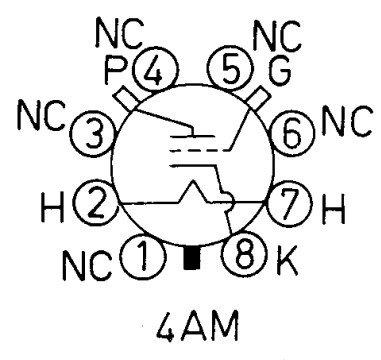
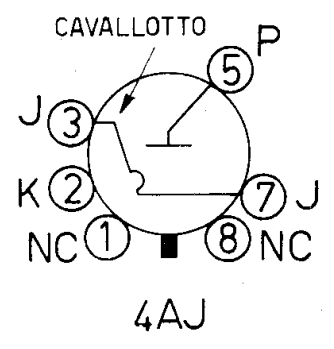
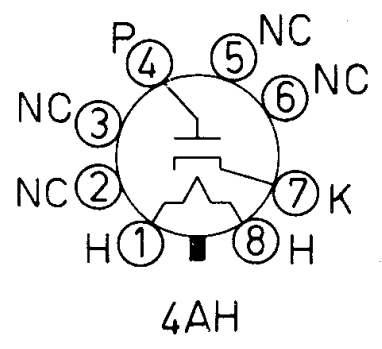
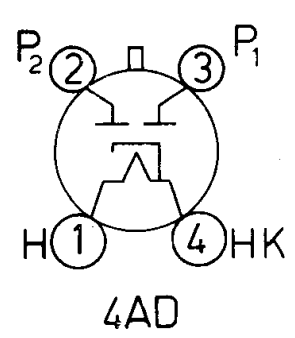

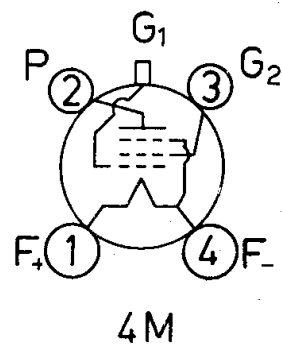
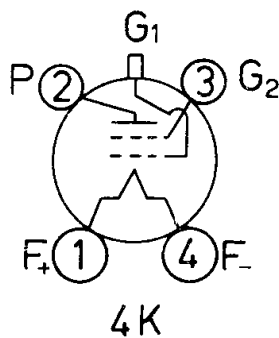
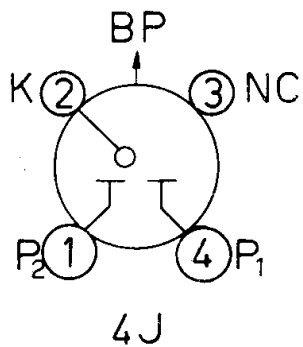
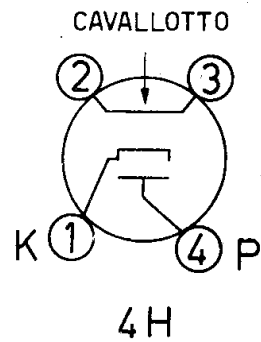
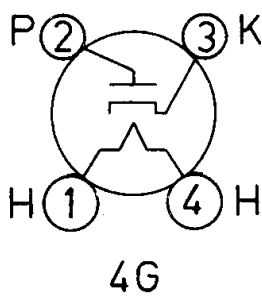
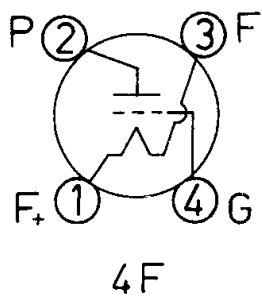
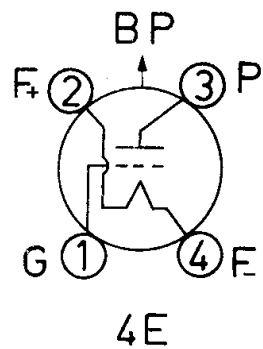
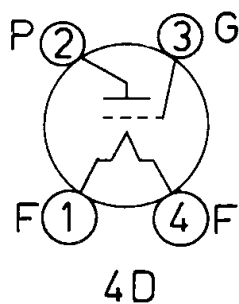
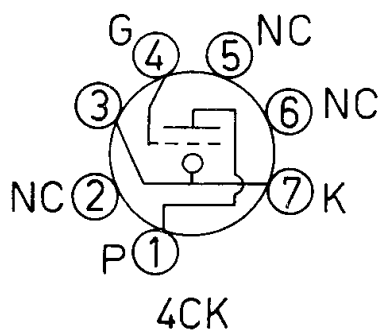
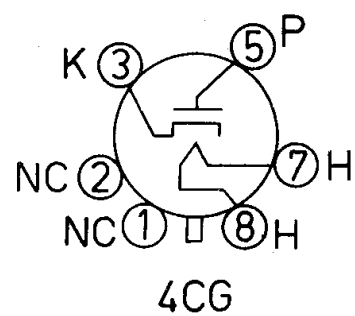
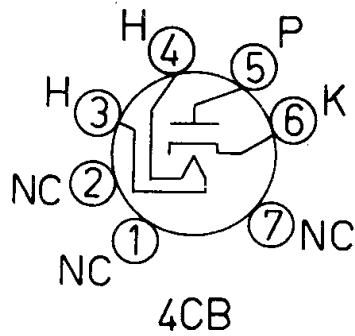
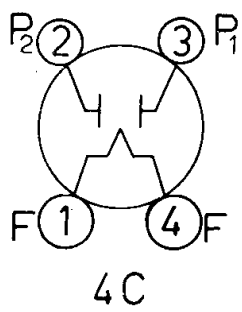

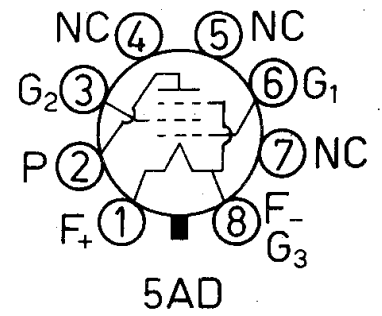
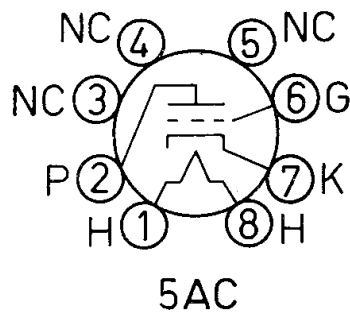
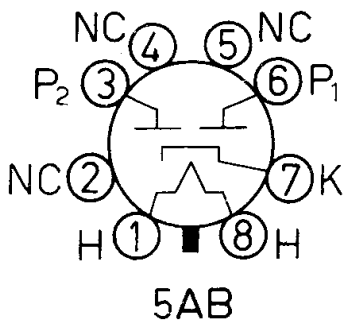
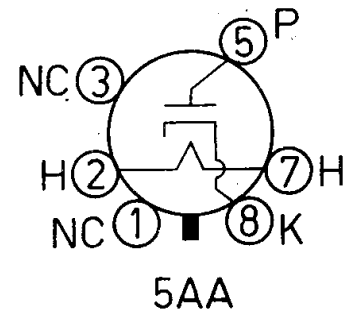
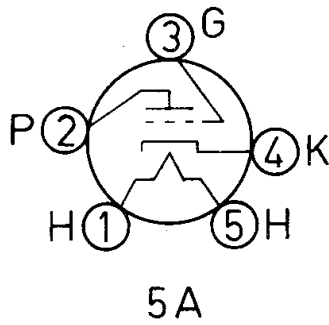
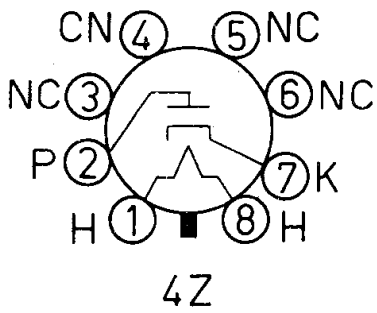
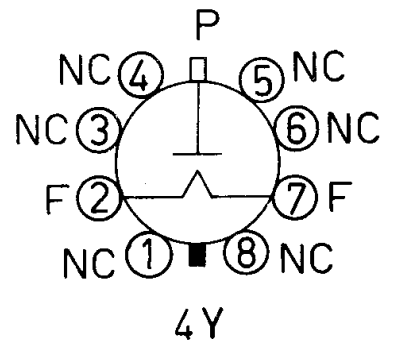
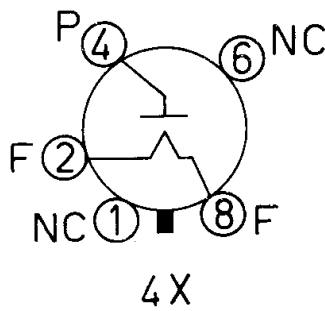
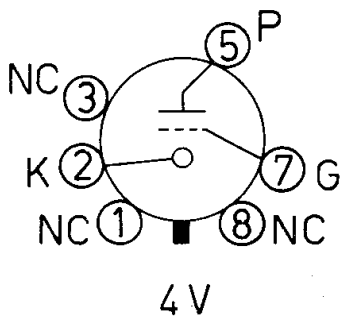
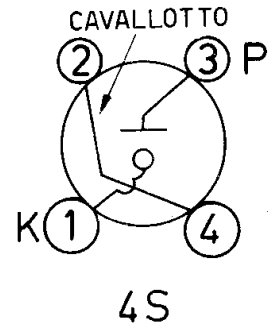
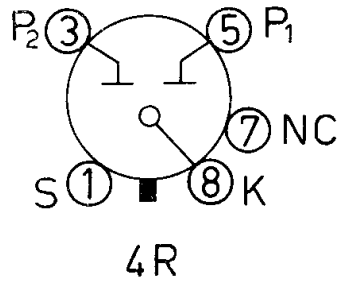
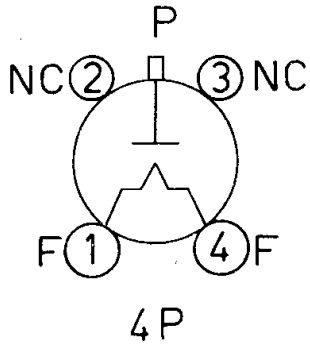

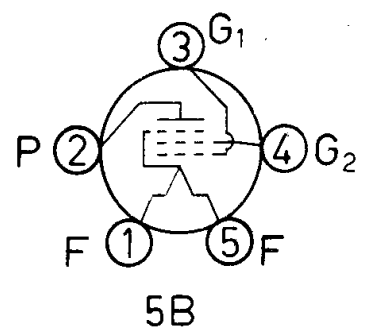
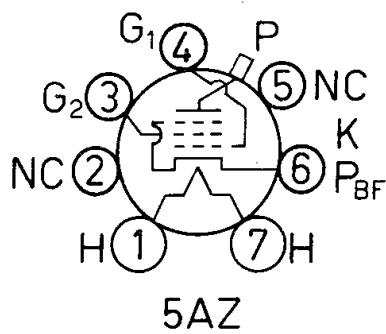
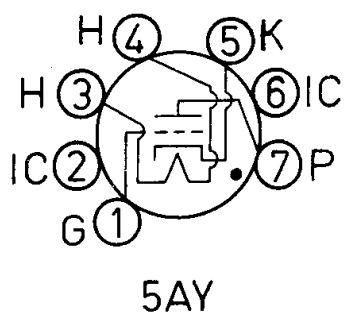
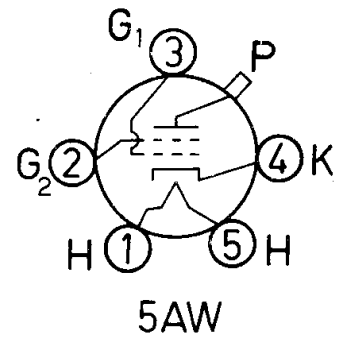
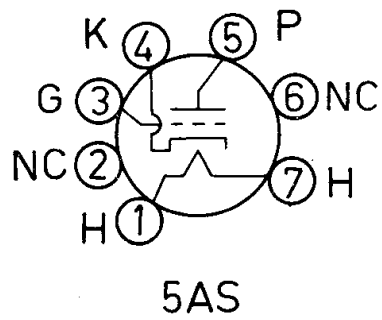
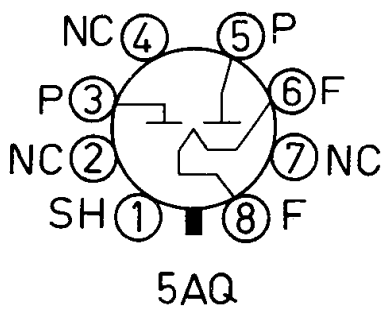
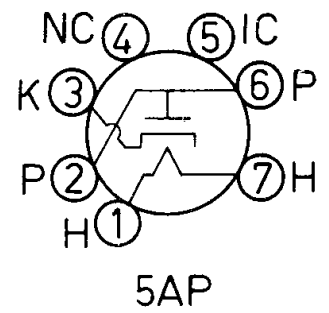
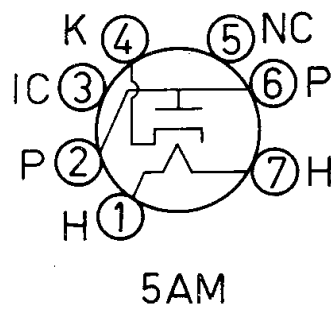
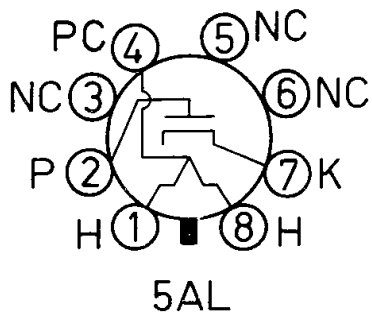
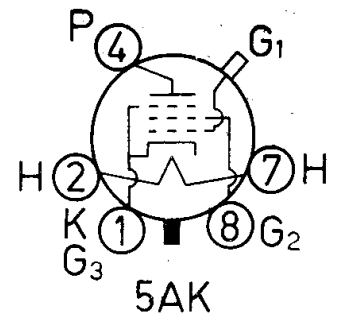
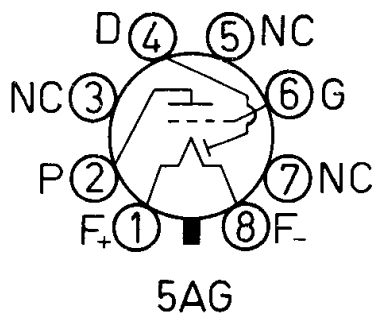
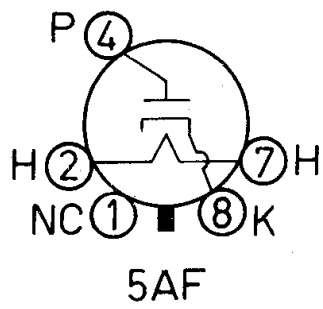

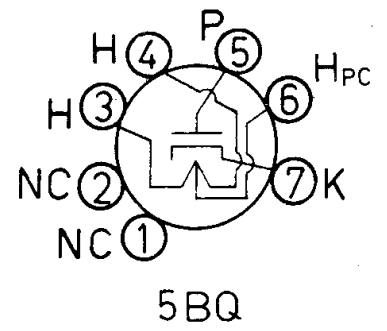
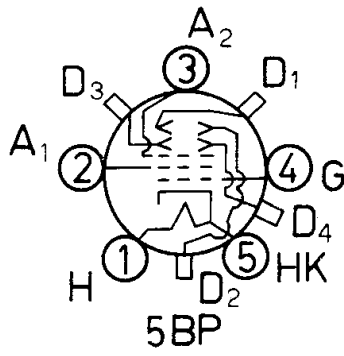
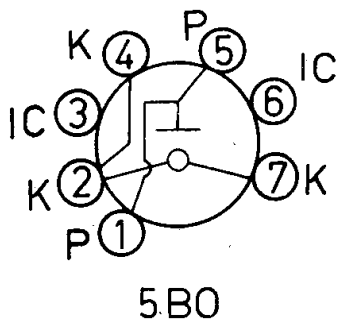
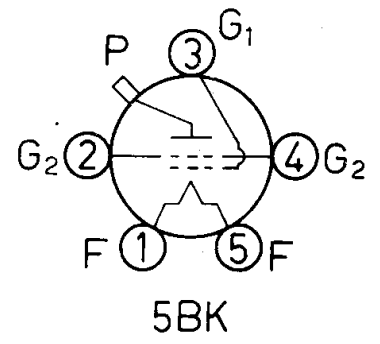
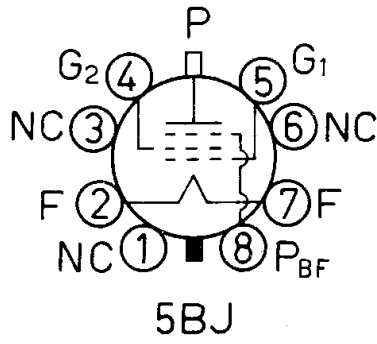
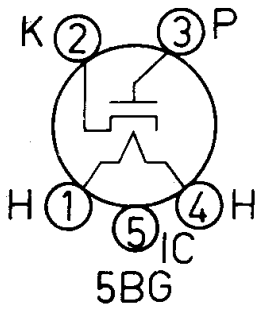
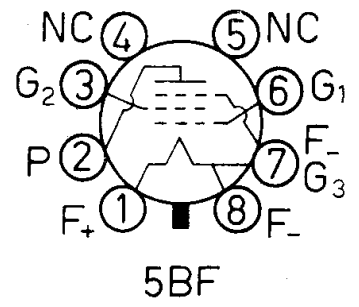
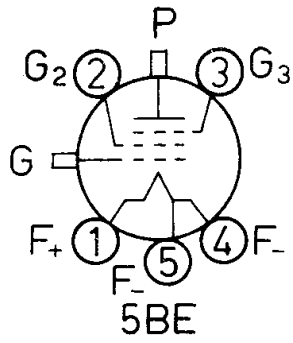
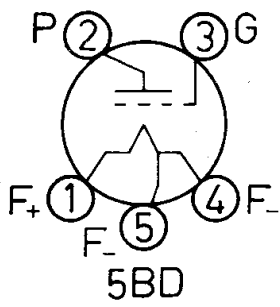
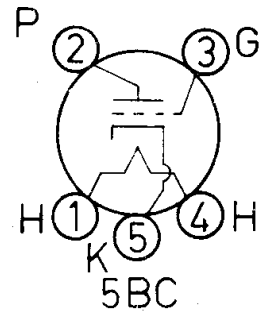
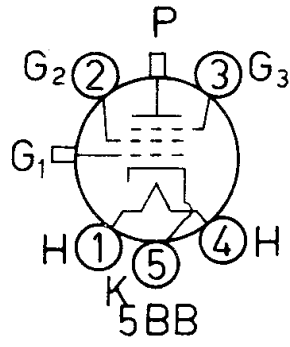
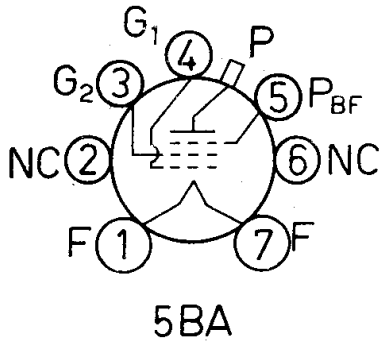

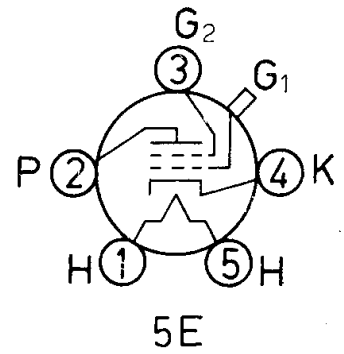
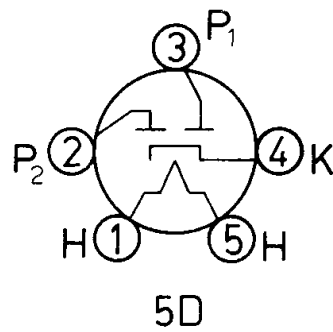
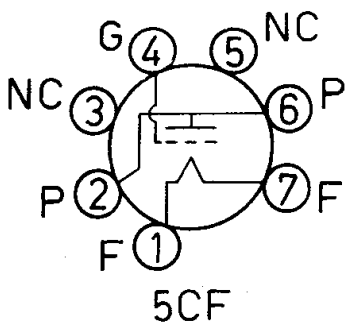
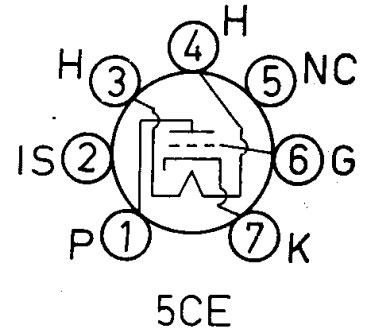
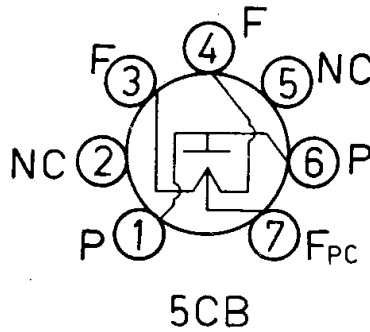
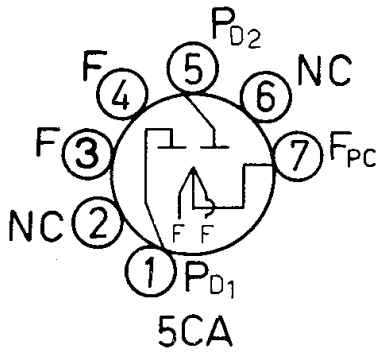
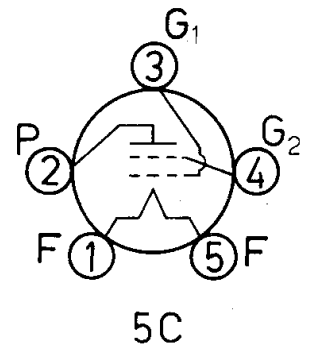
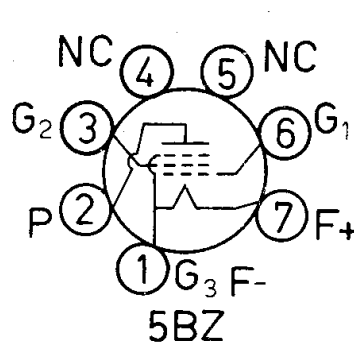
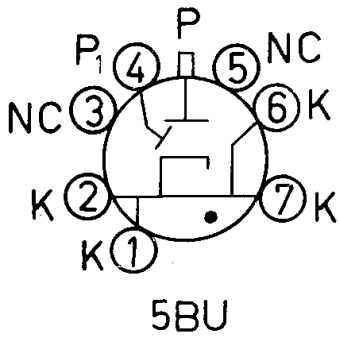
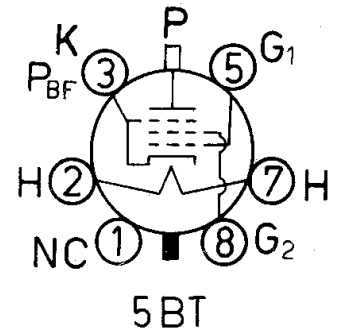
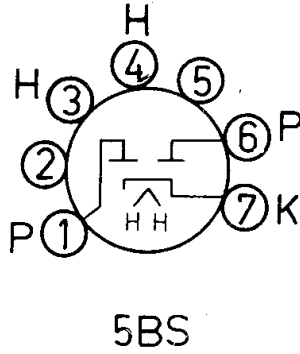
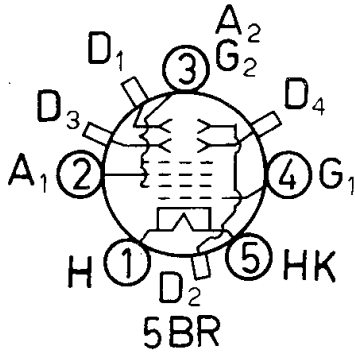

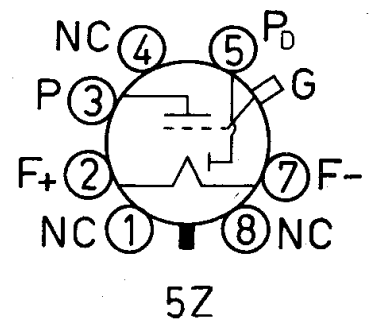
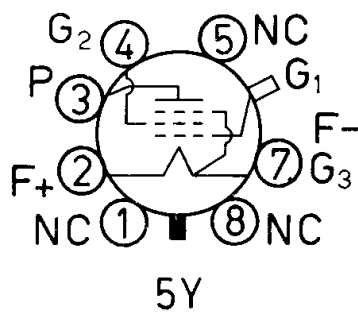
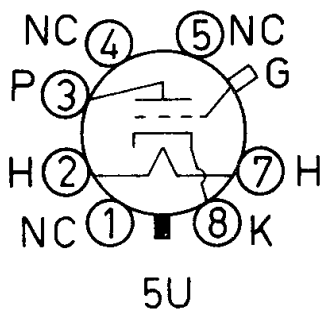
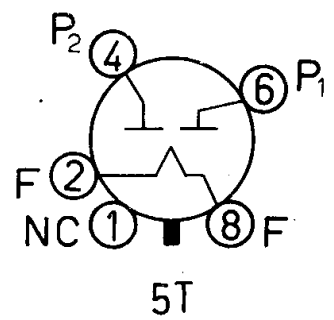
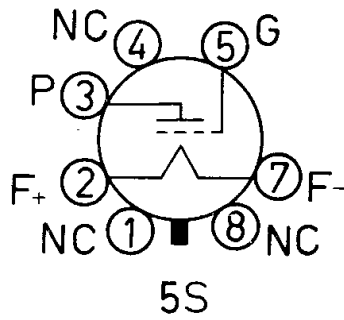
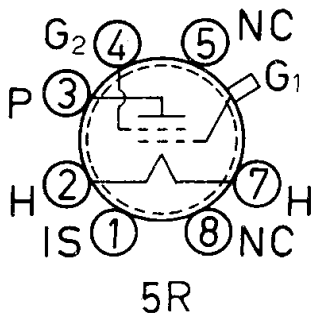
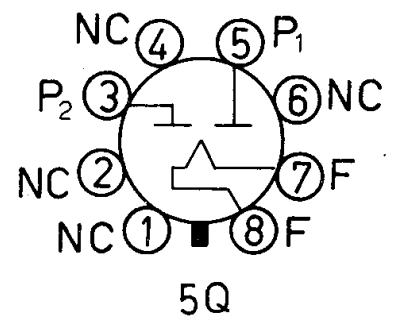
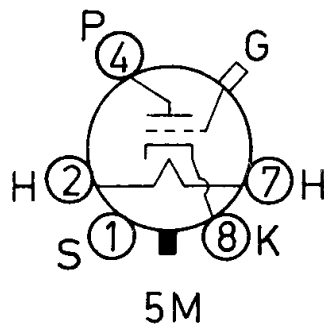
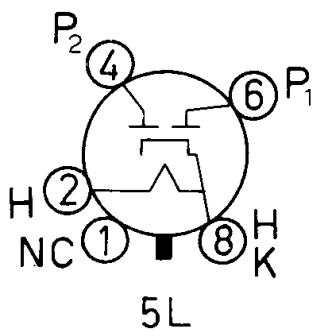
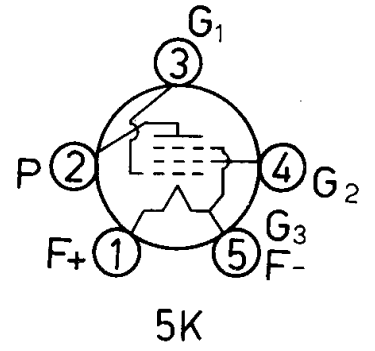
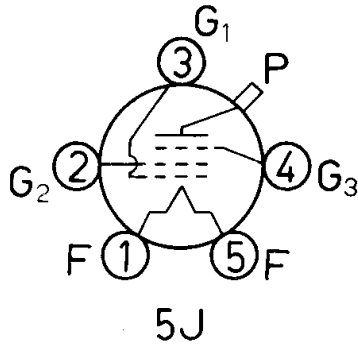
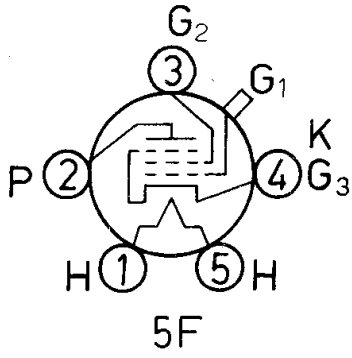

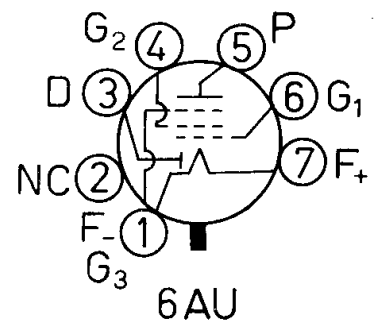
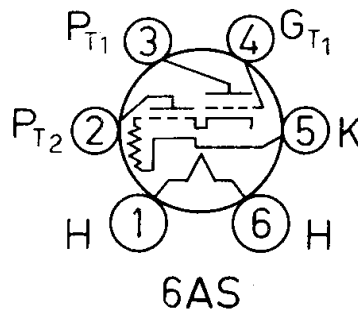
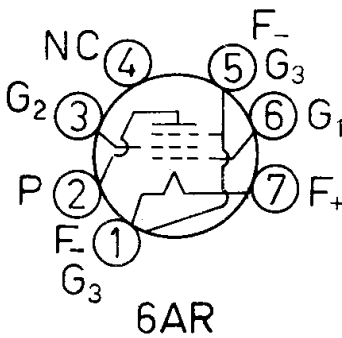
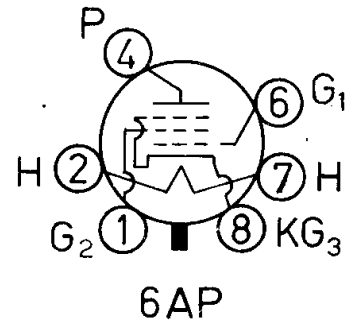
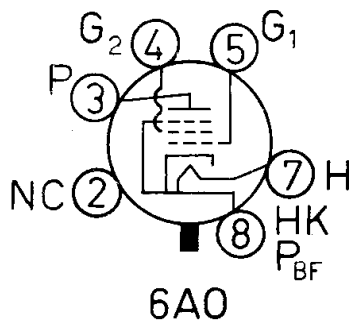
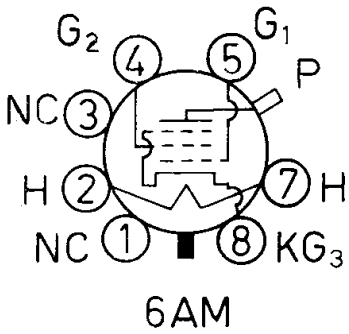
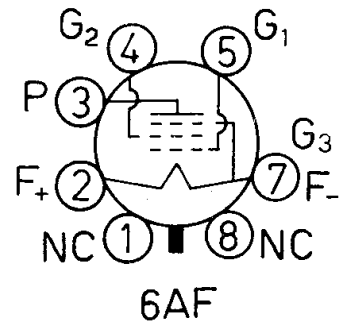
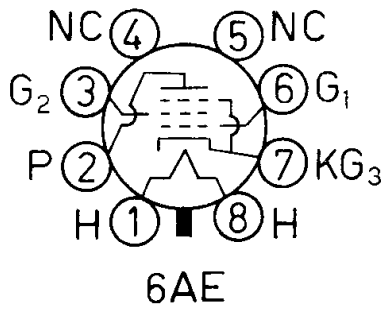
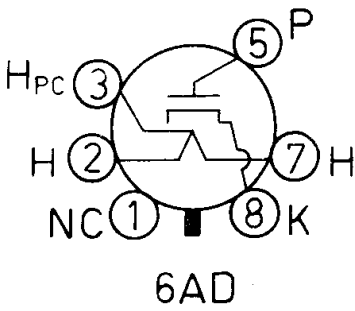
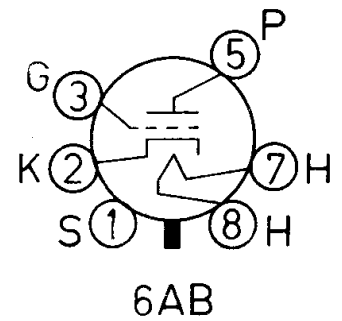
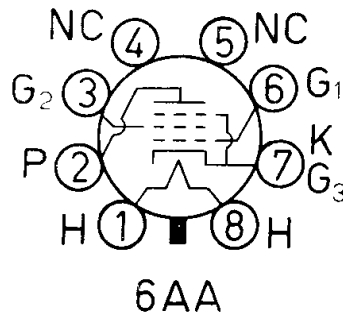
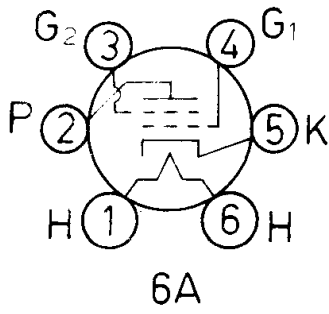

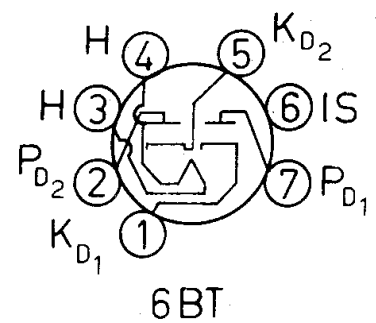
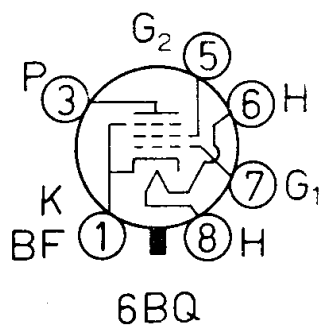
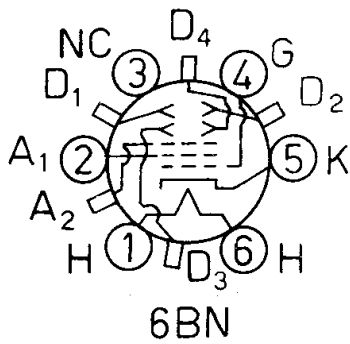
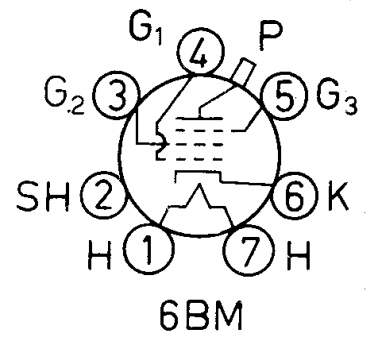
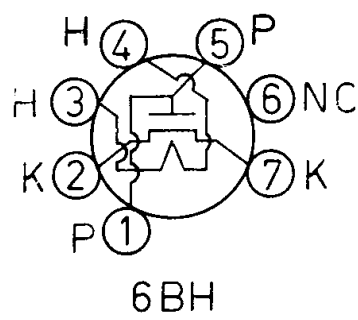
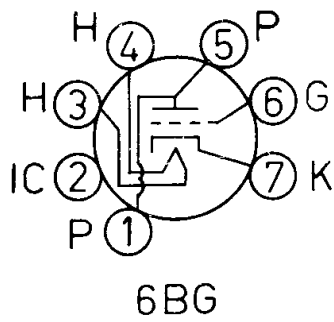
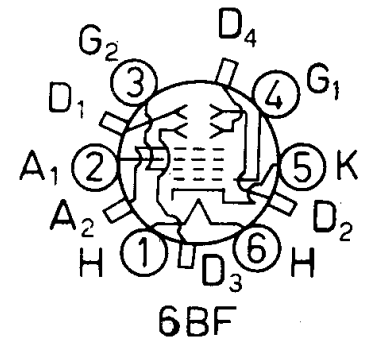
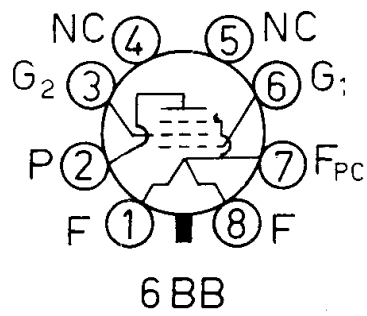
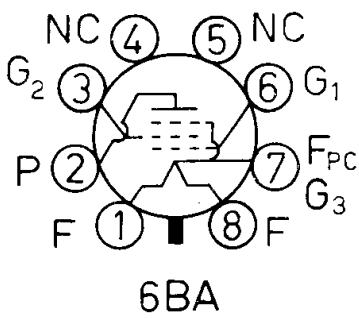
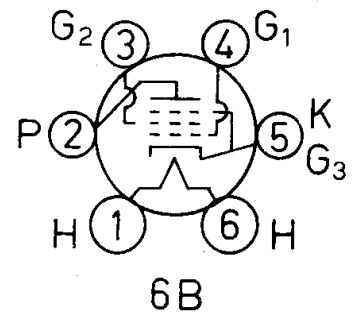
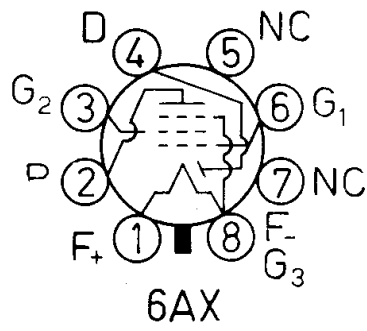
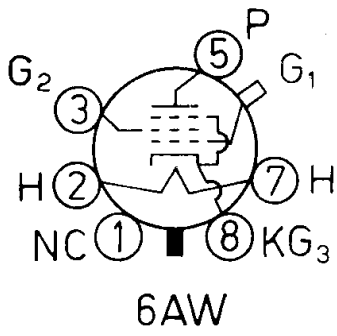

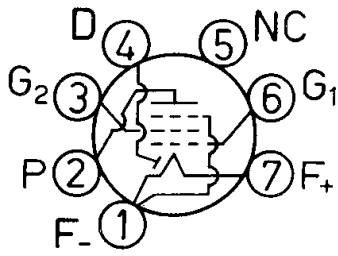

6BW

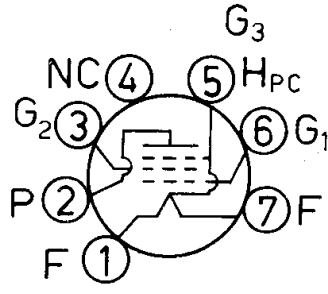

6BX

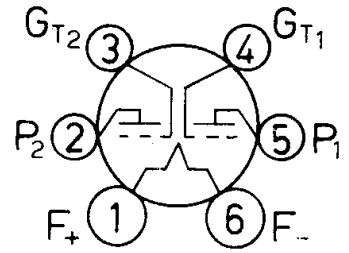

6C

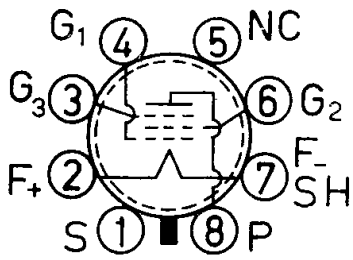

6CA

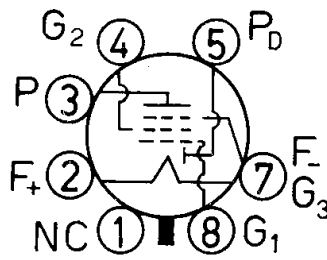

6CB

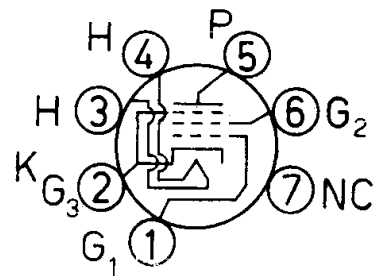

6CC

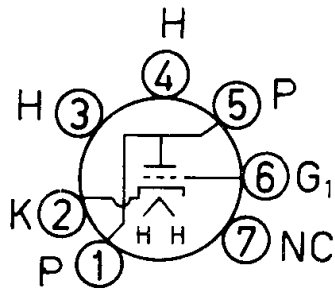

6CG

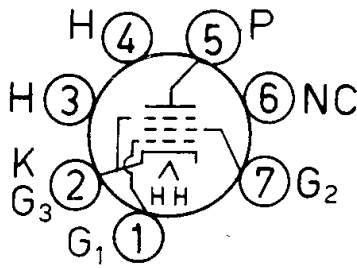

6CH

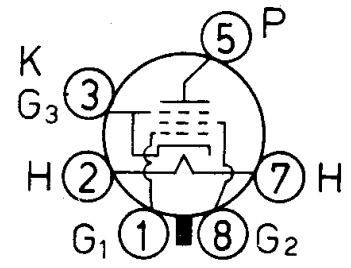

6CK

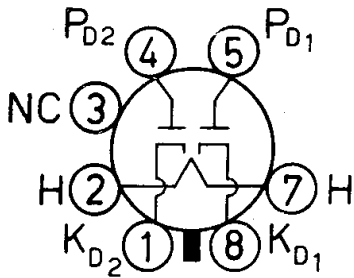

6CN

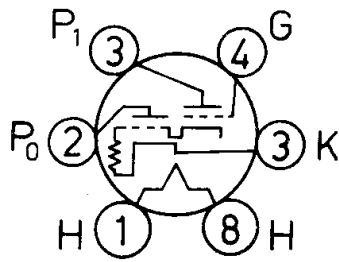

6D

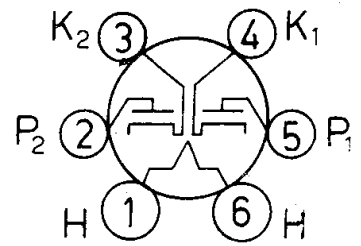

6E

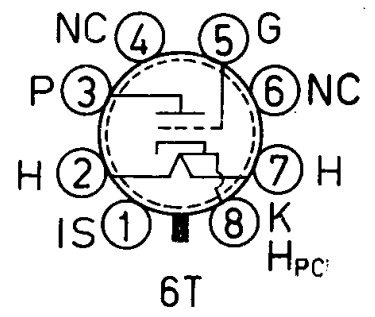
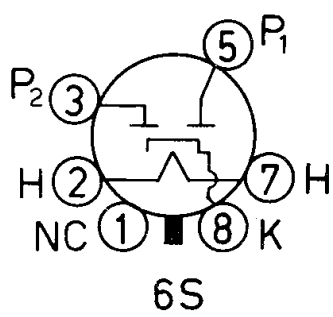
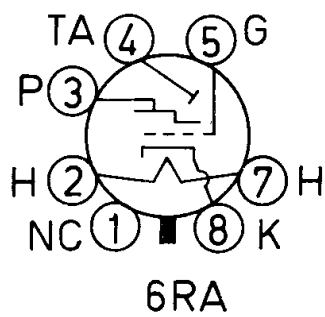
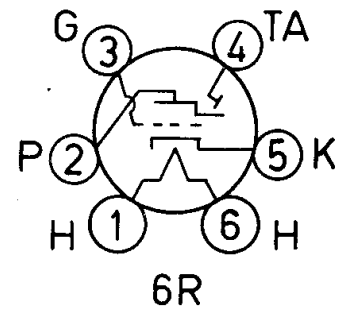
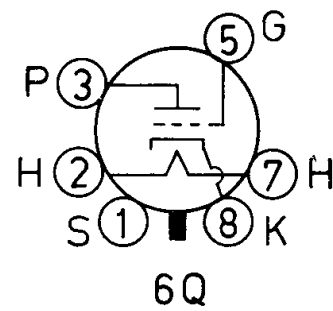
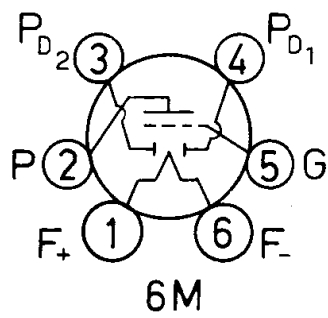
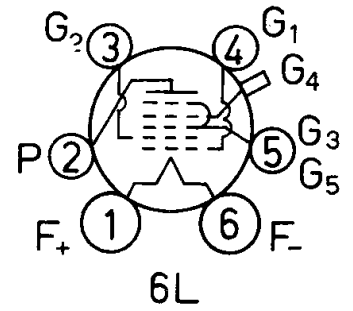
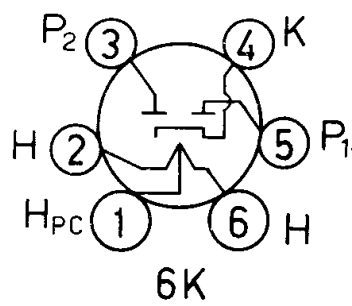
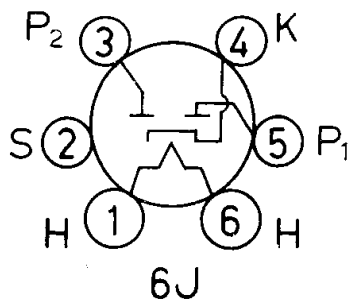
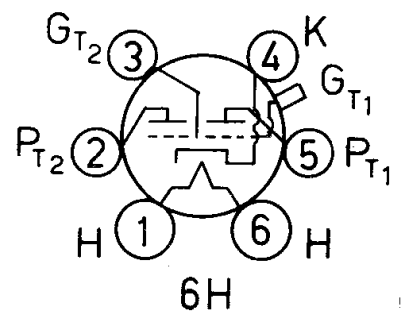
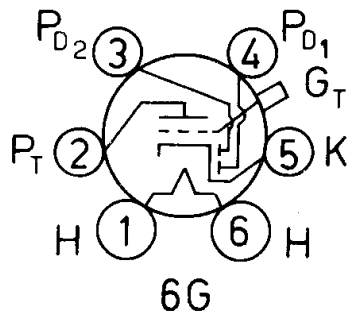
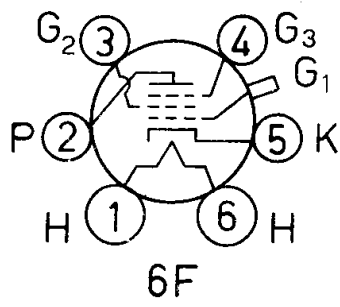

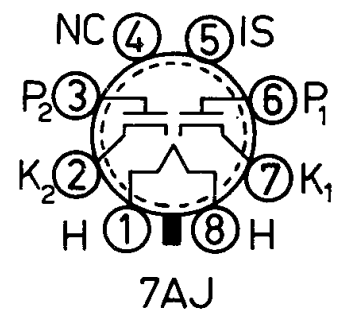
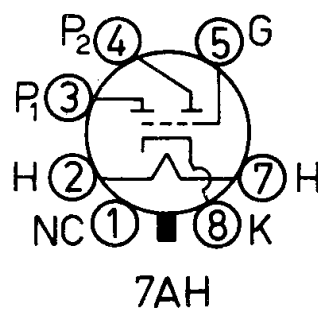
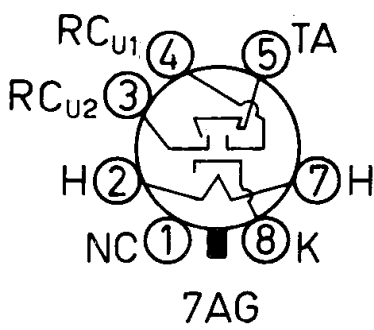
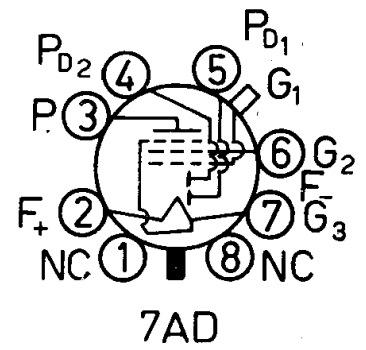
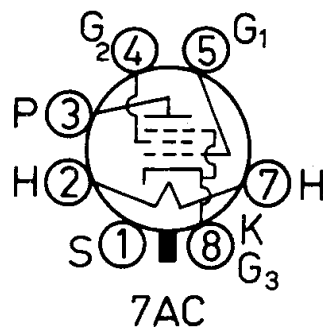
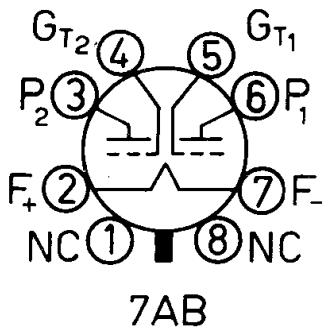
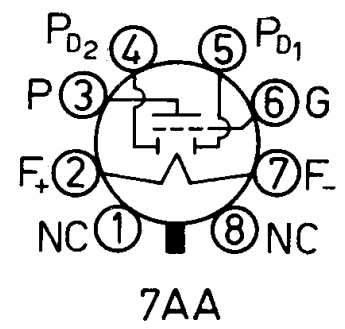
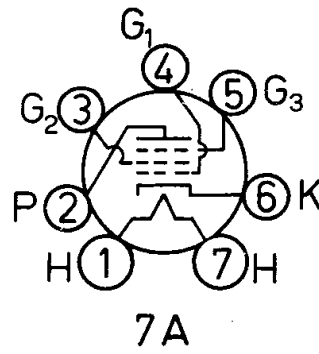
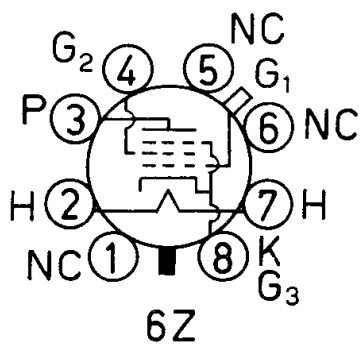
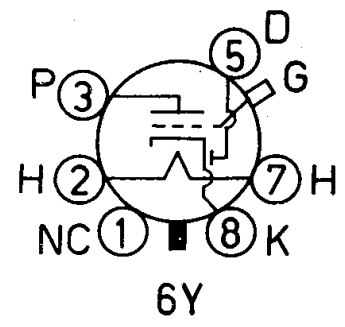
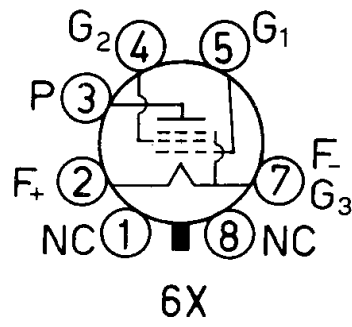
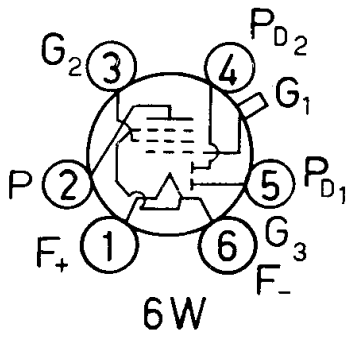

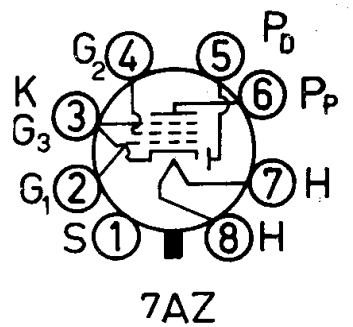
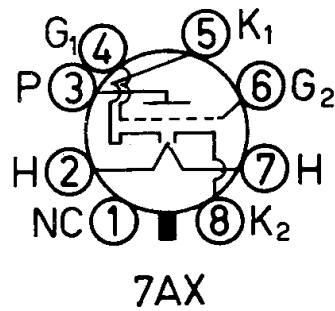
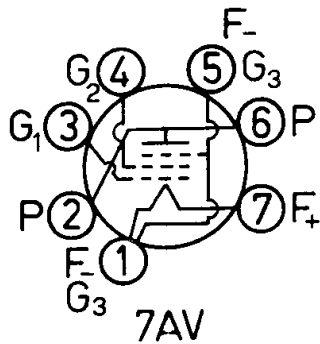
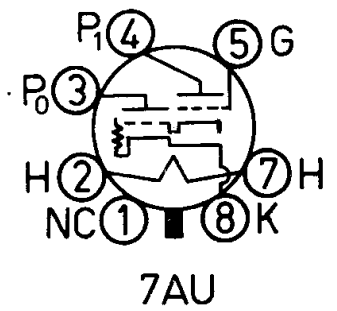
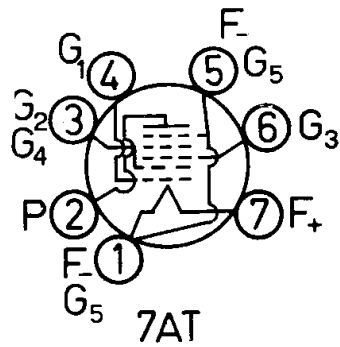
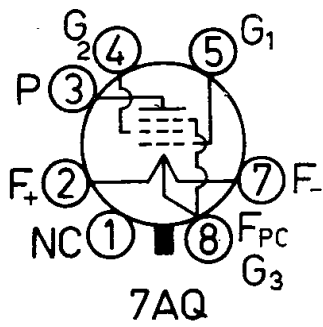
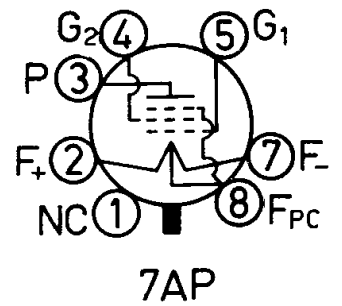
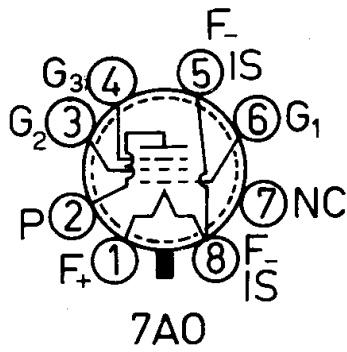
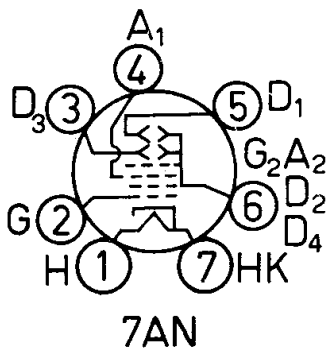
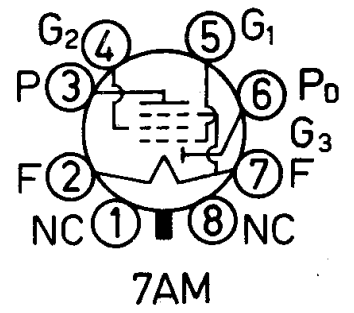
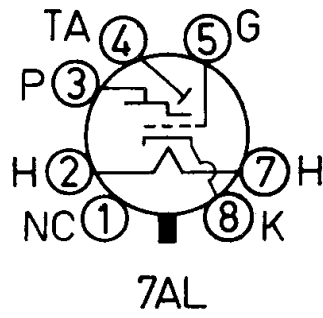
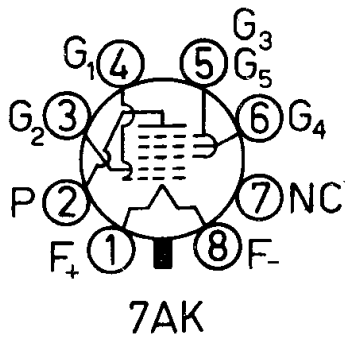

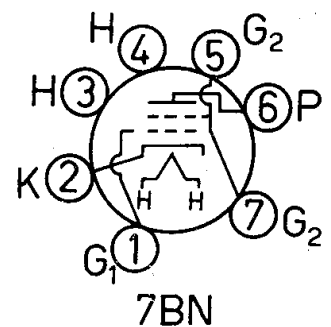
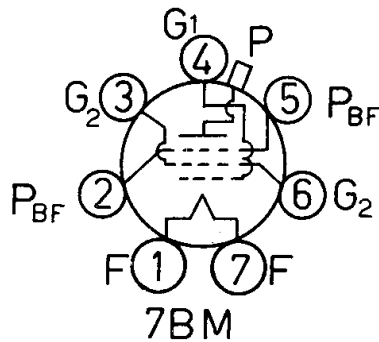
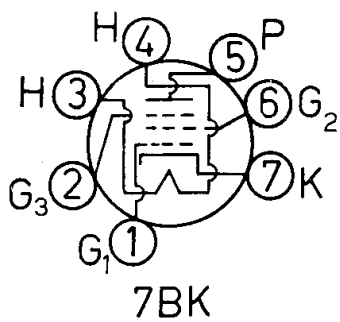
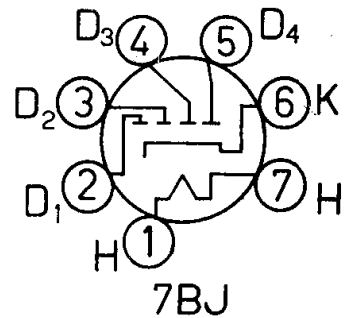
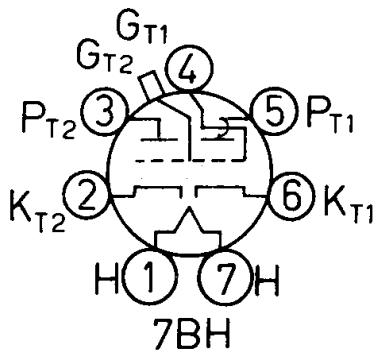
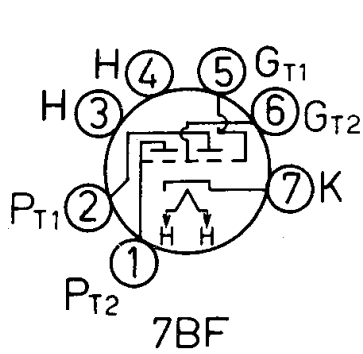
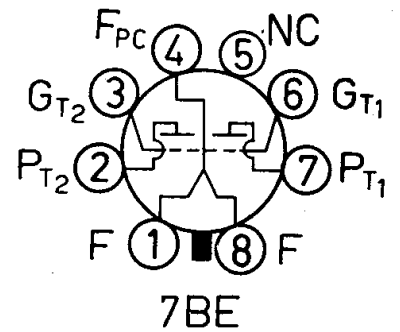
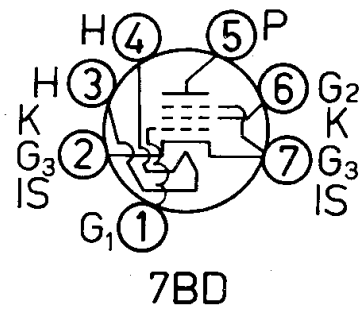
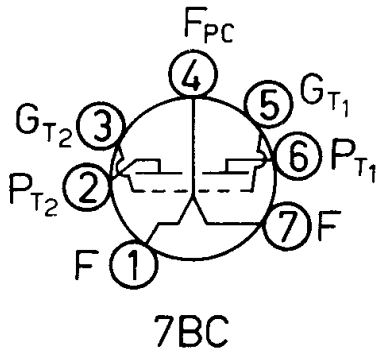
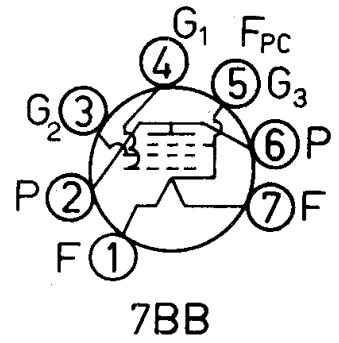
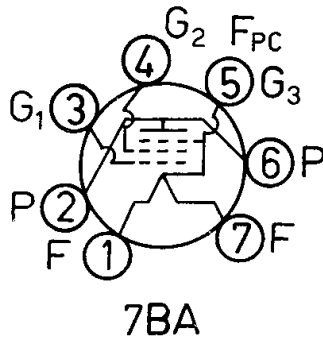
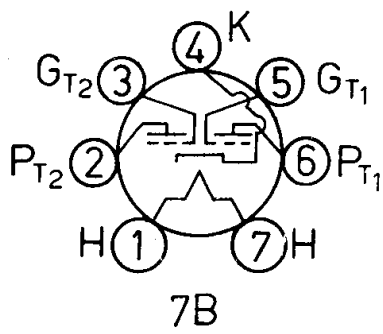

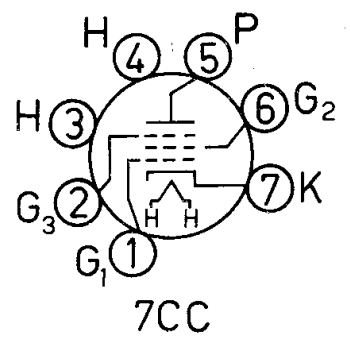
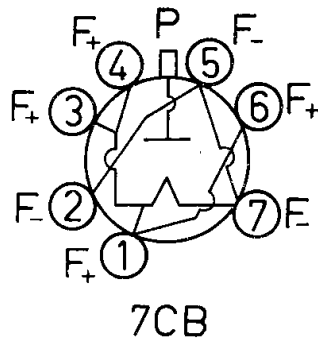
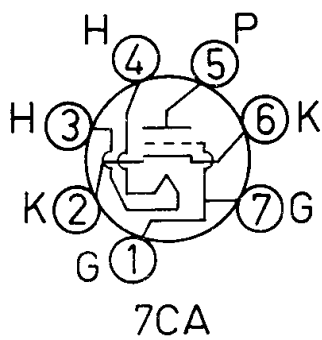
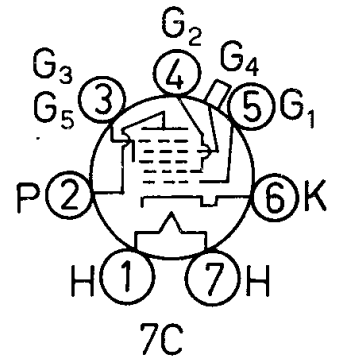
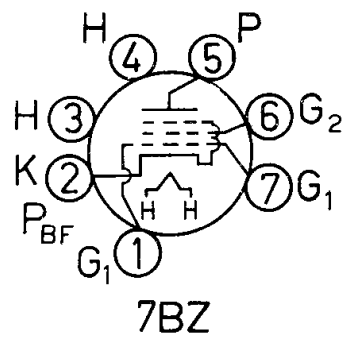
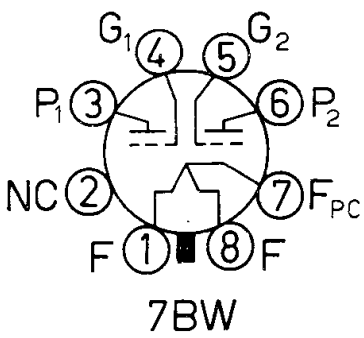
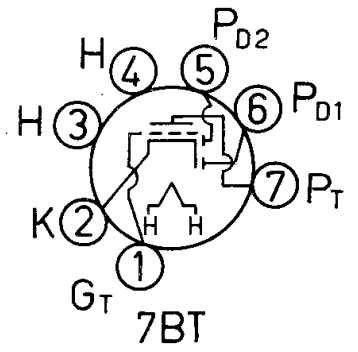
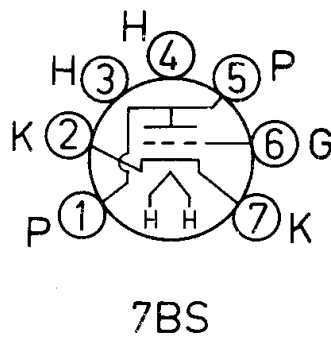
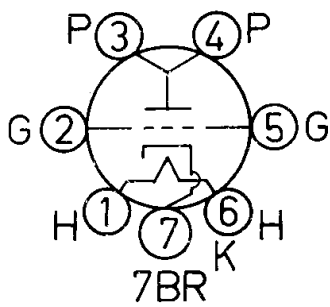
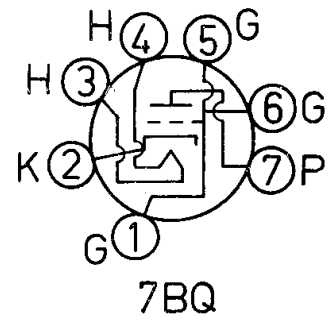
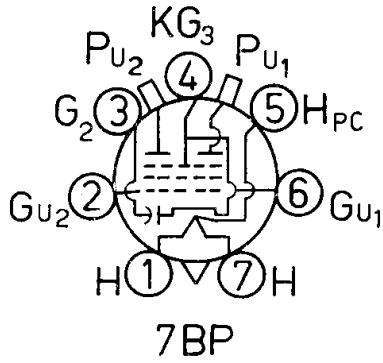
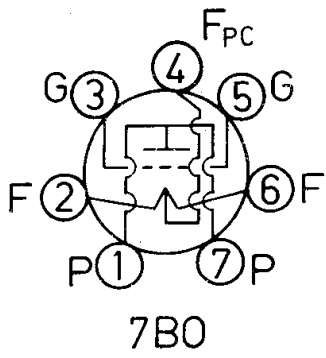

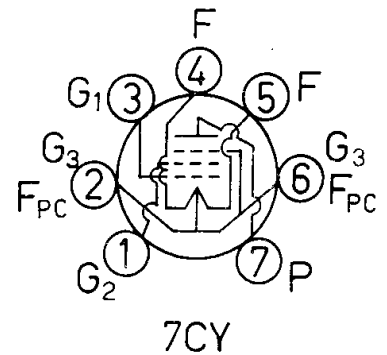
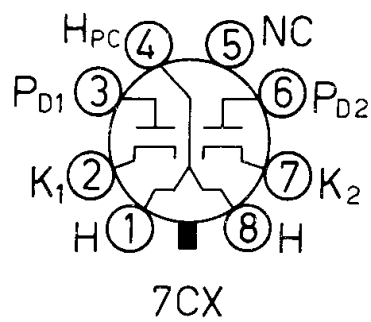
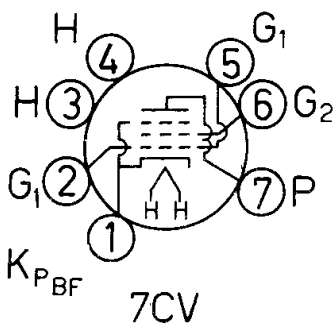
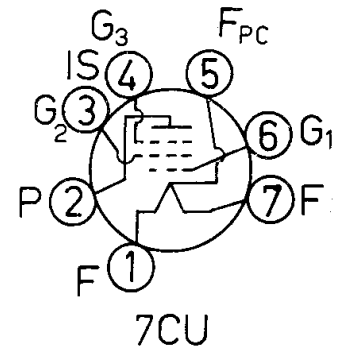
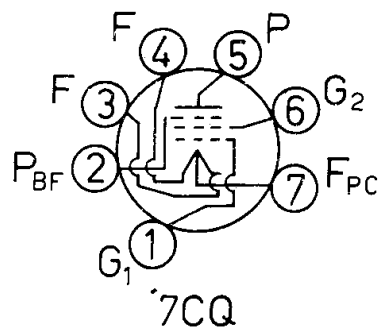
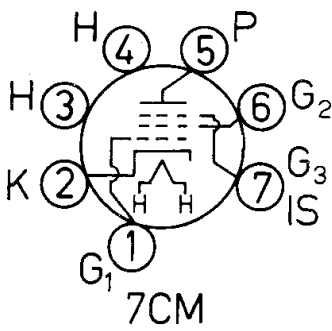
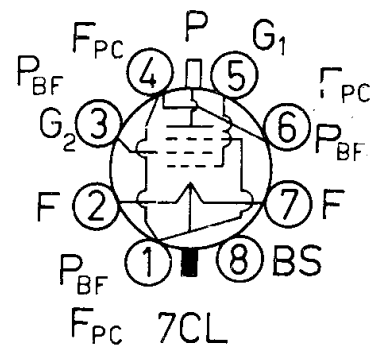
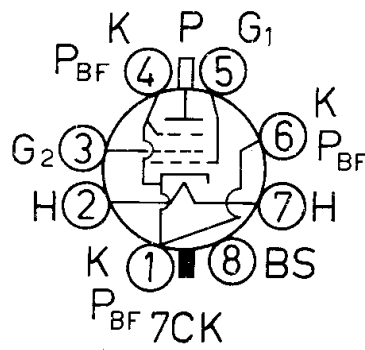
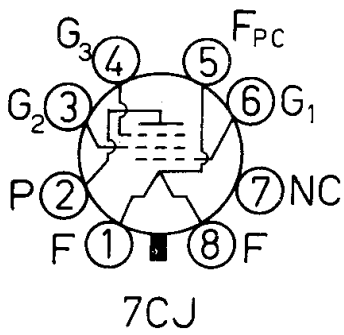
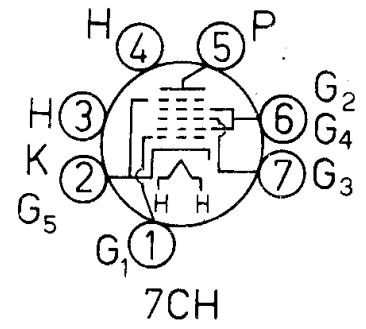
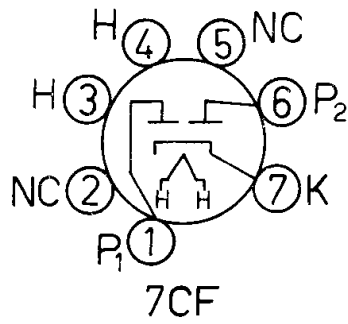
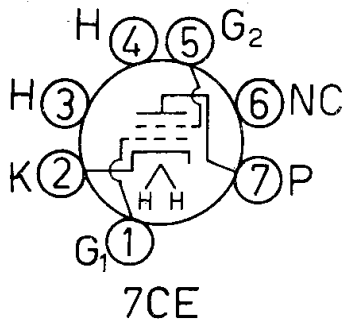

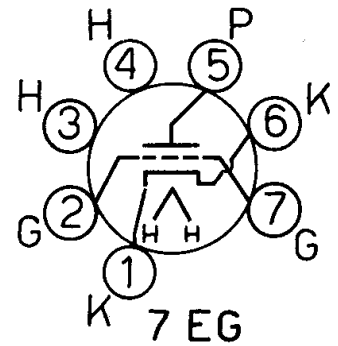
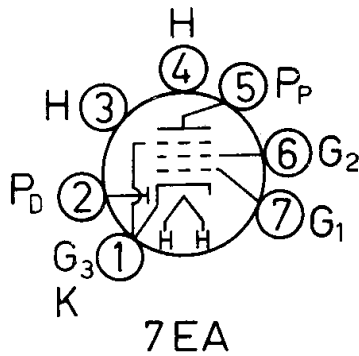
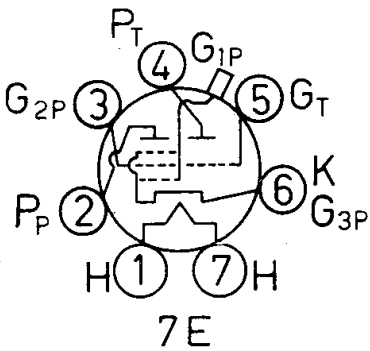
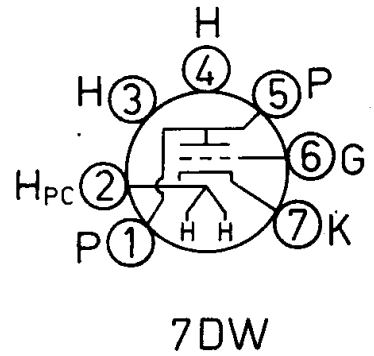
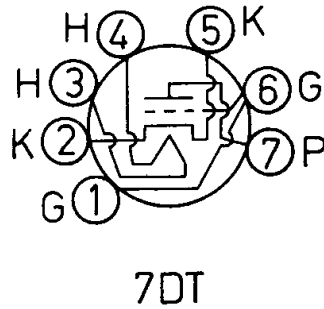
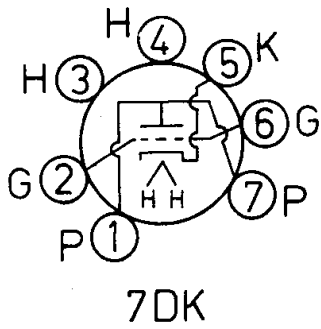
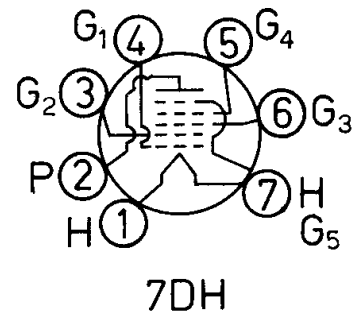
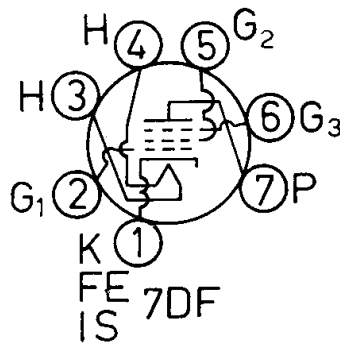
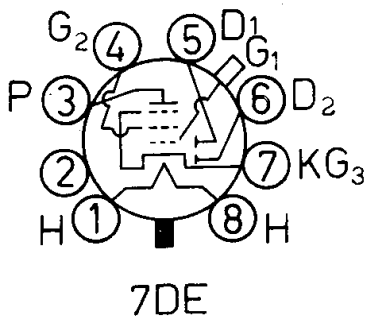
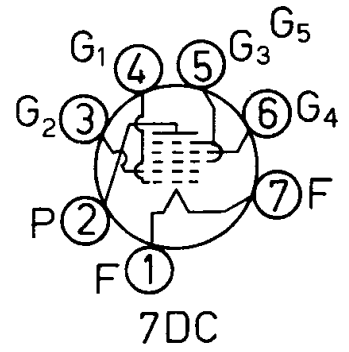
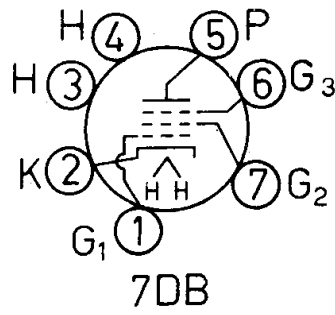
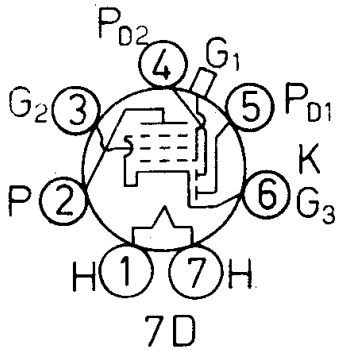

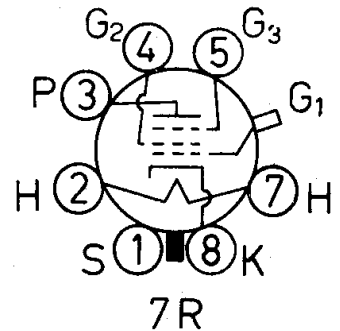
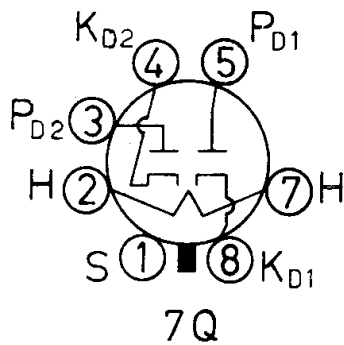
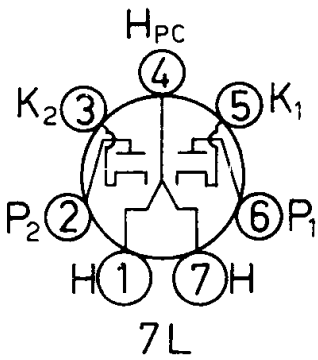
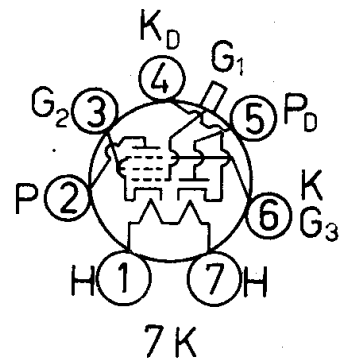
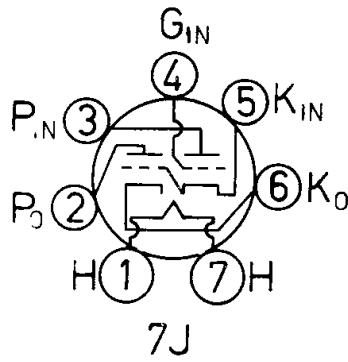
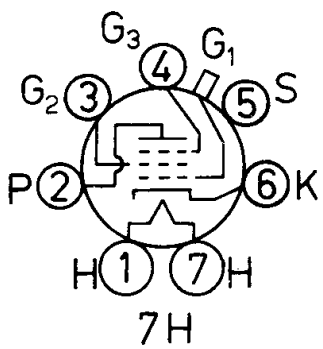
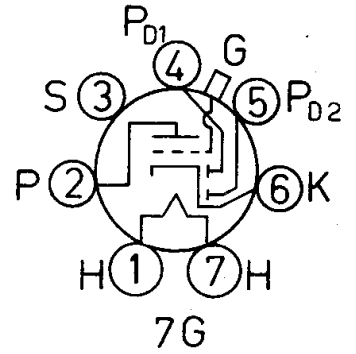
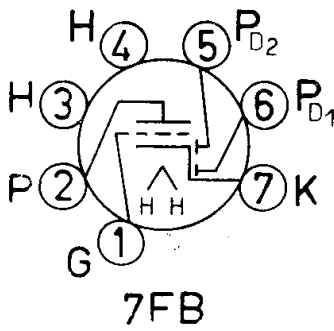
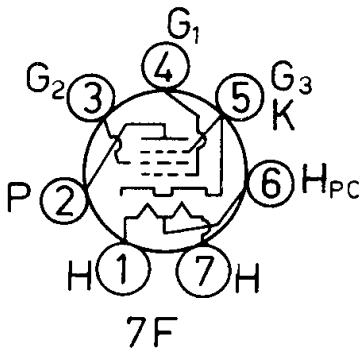
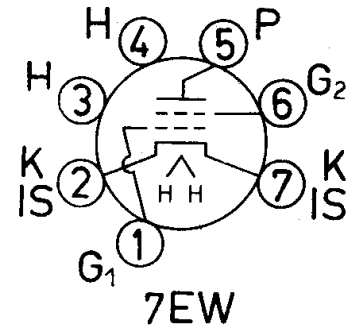
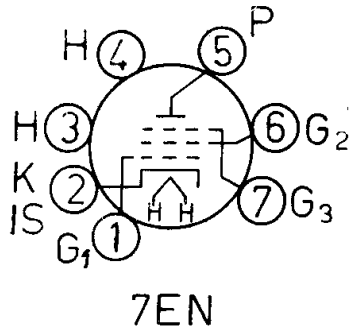
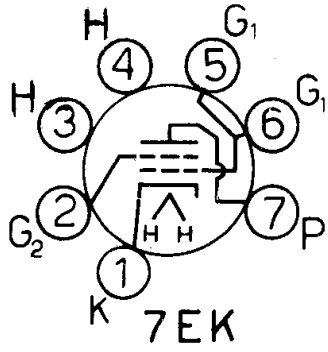

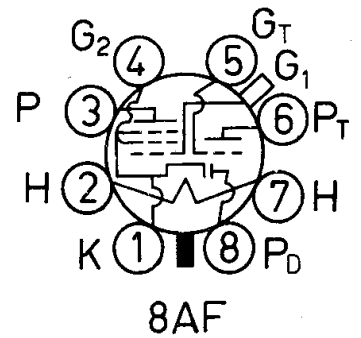
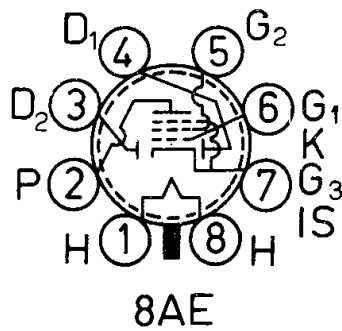
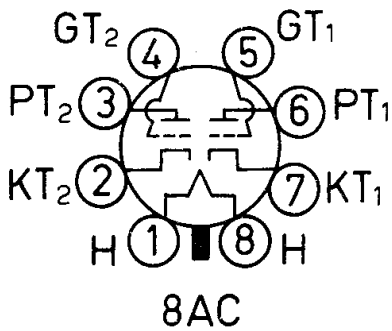
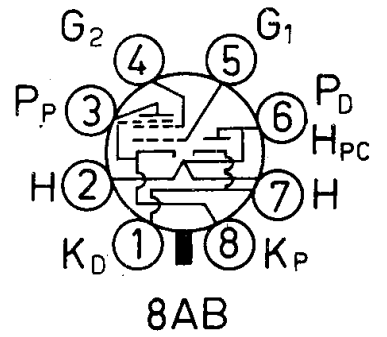
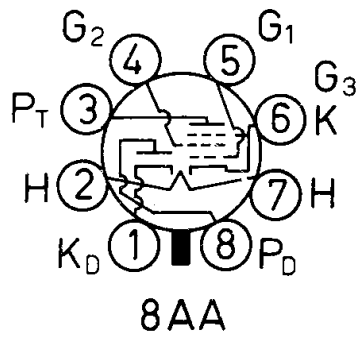
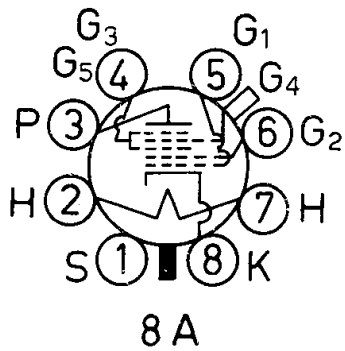
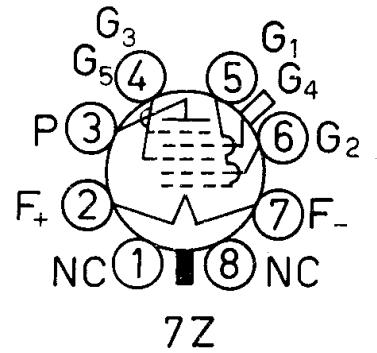
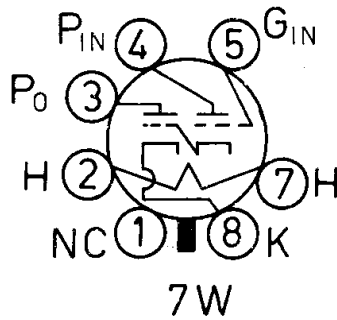
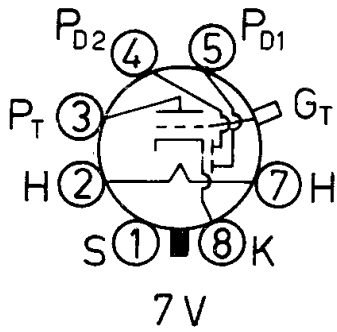
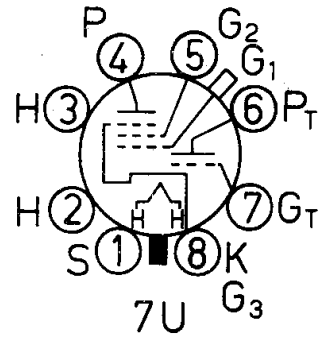
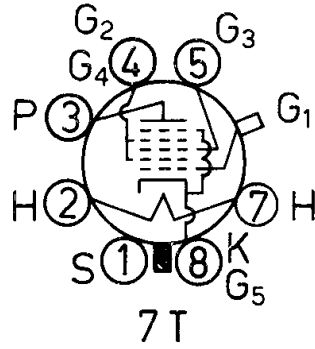
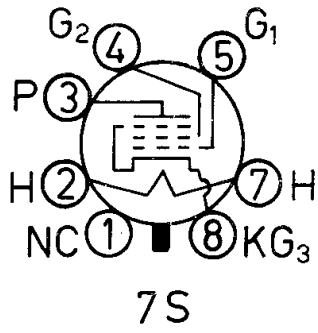

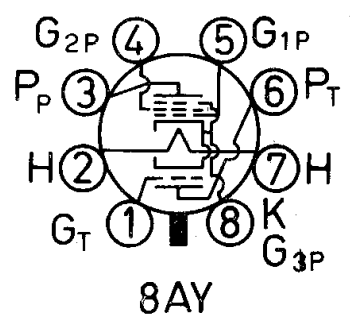
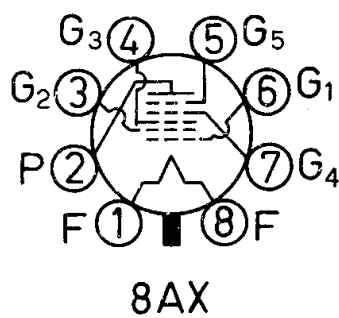
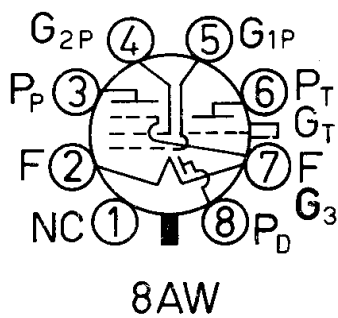
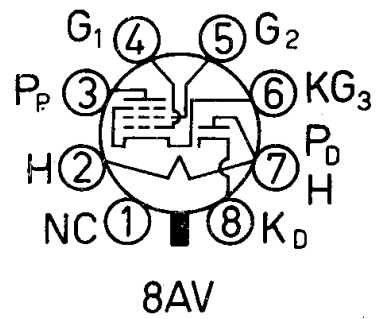
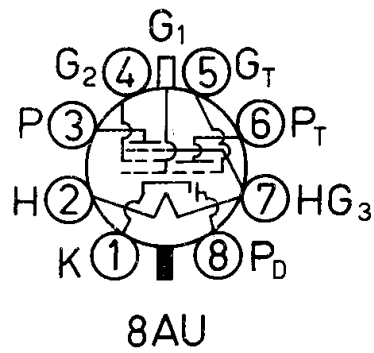
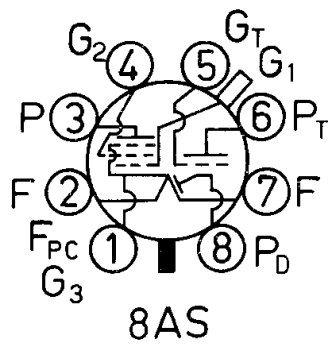
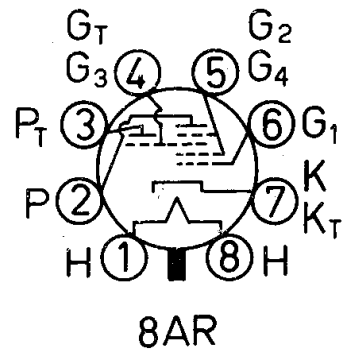
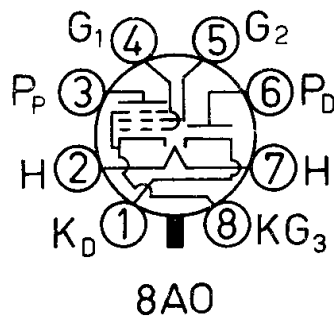
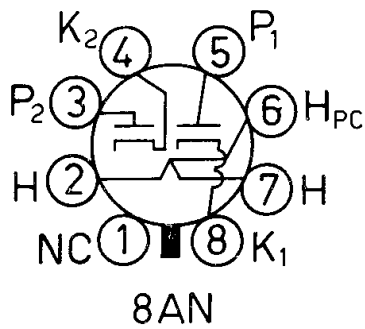
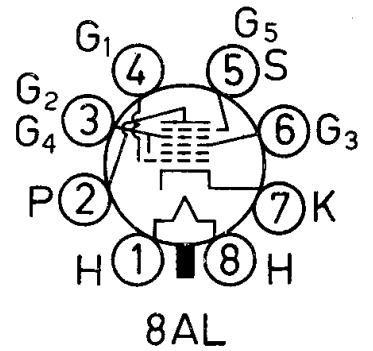
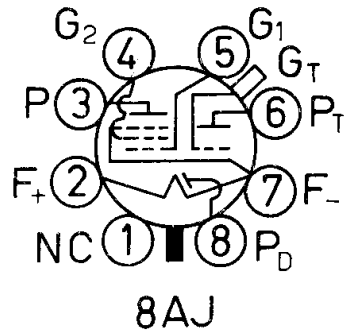
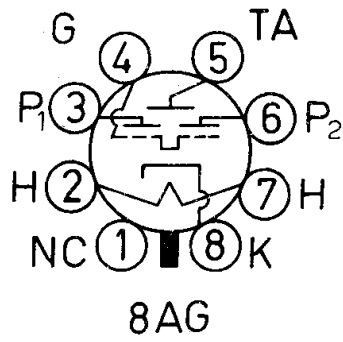

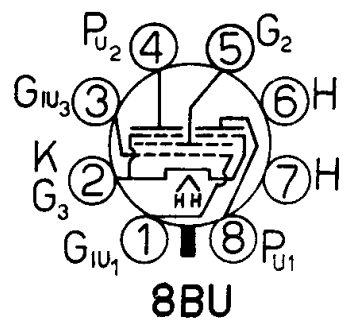
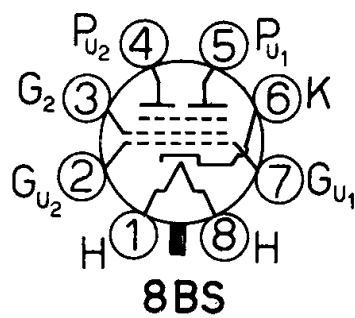
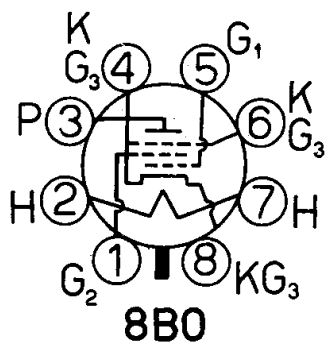
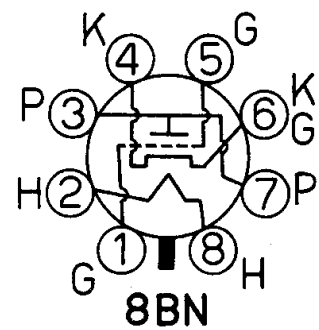
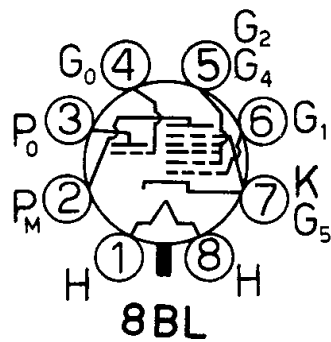
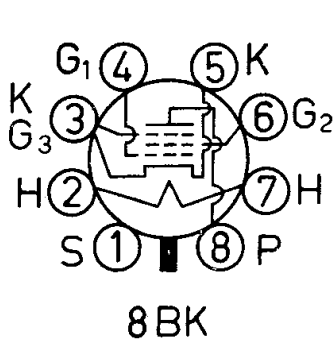
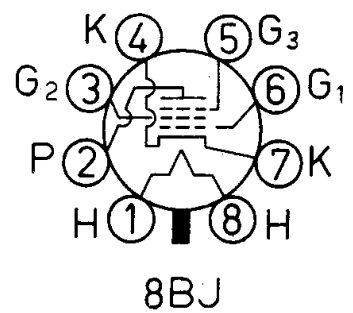
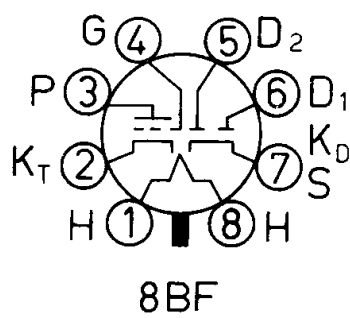
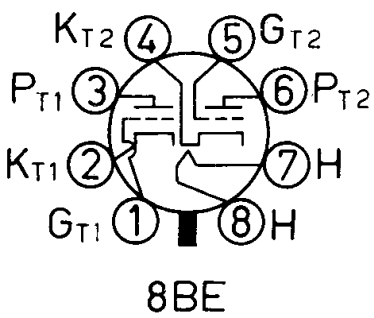
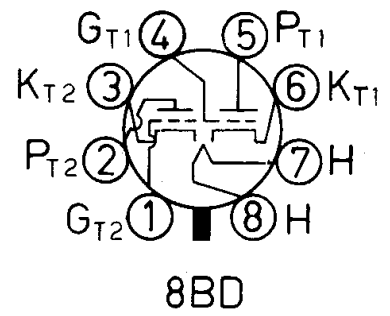
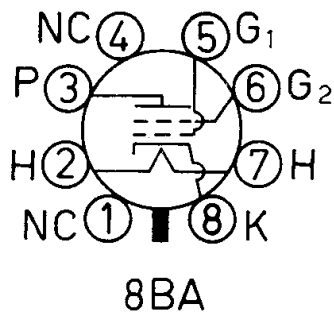
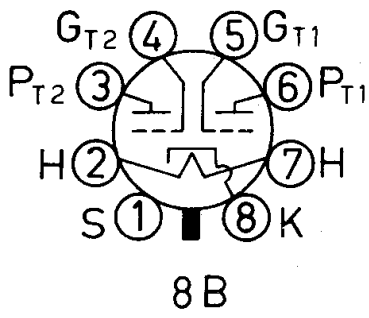

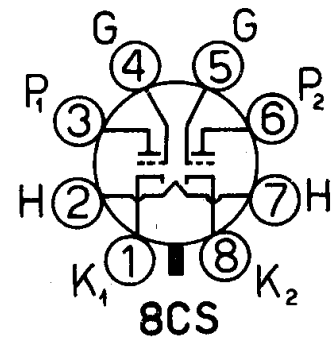
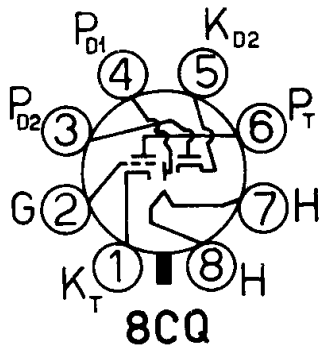
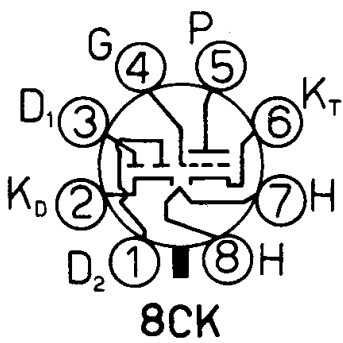
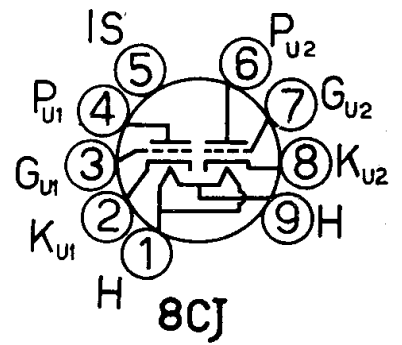
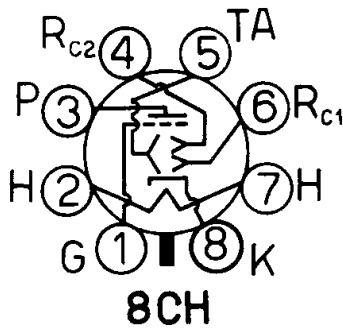
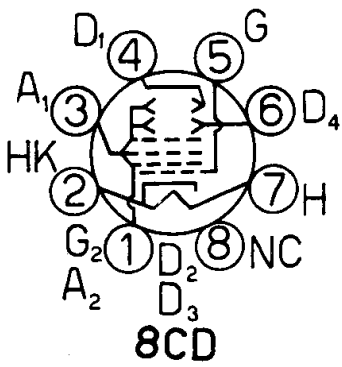
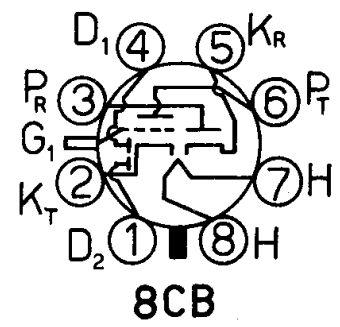
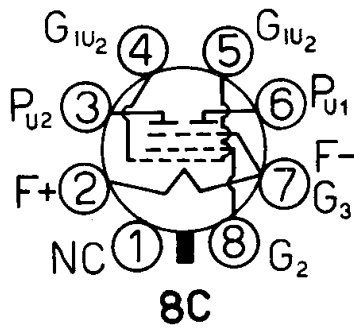
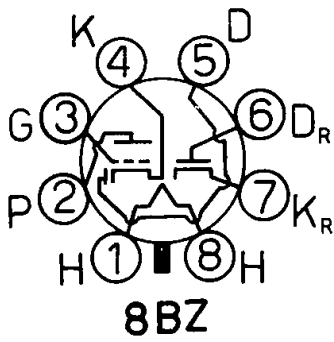
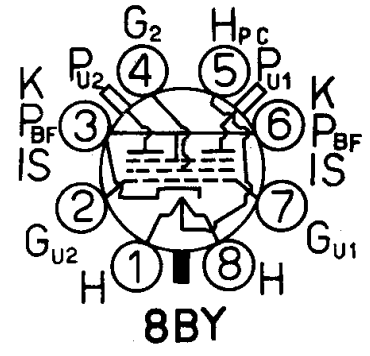
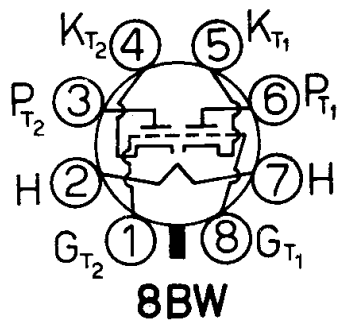
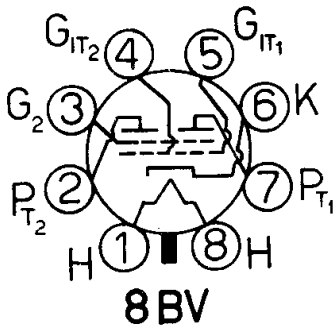

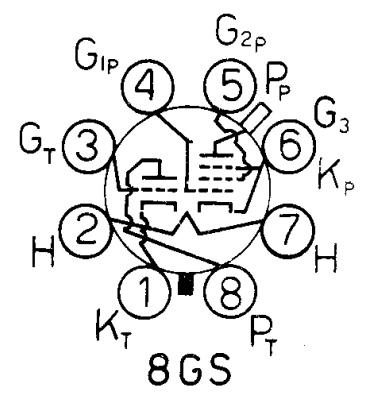
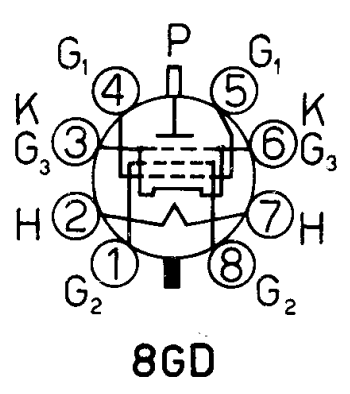
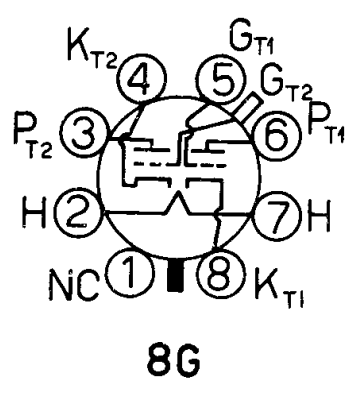
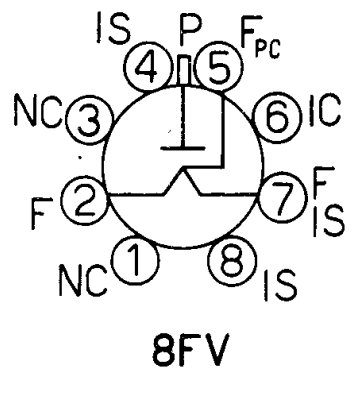
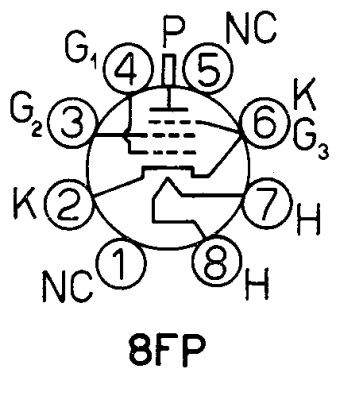
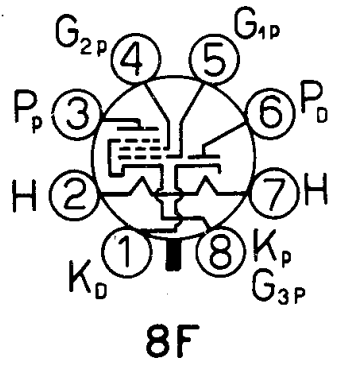
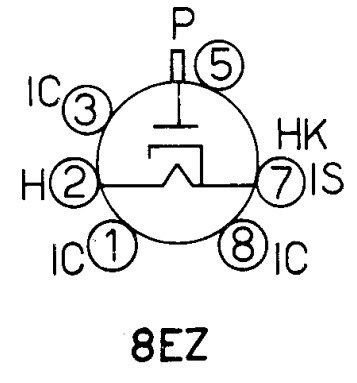
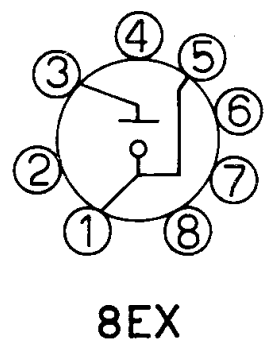
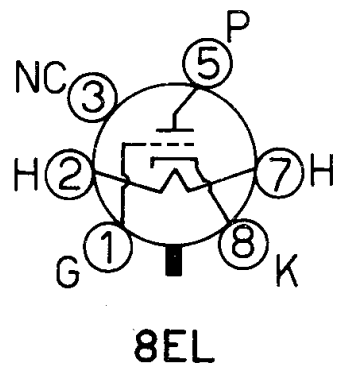
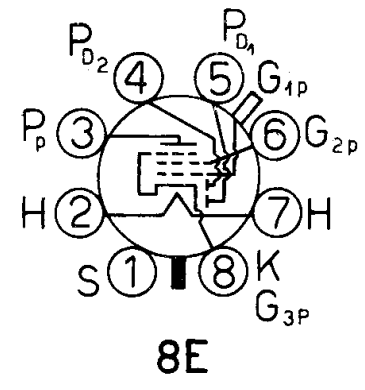
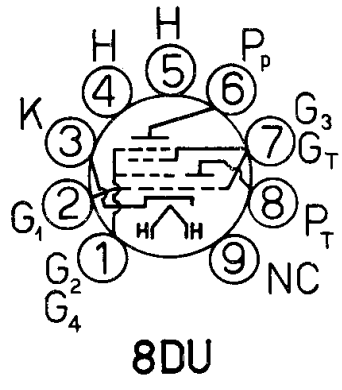
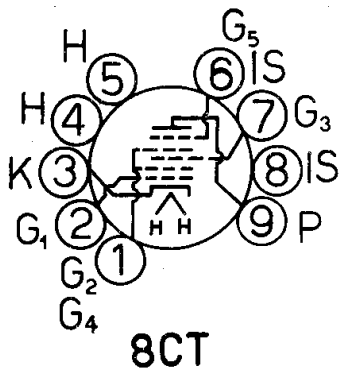

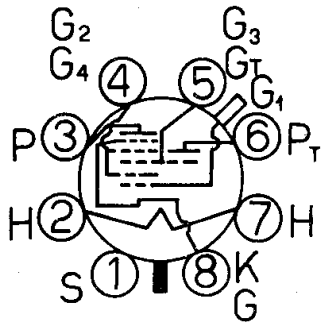

8H

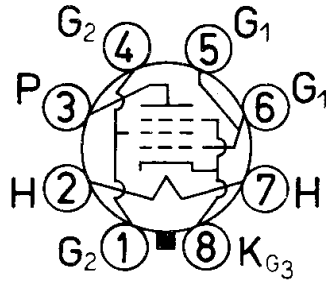

8HY

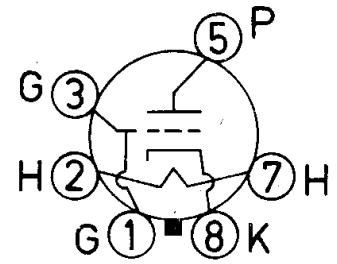

8JB

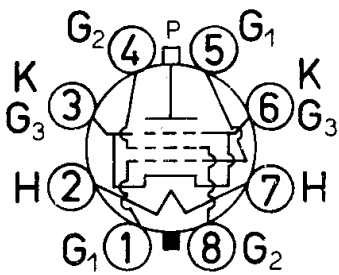

8JC

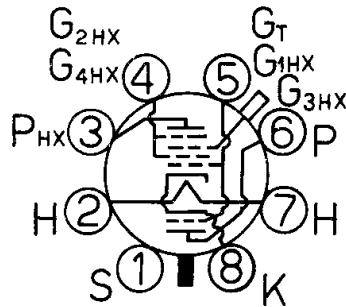

8K

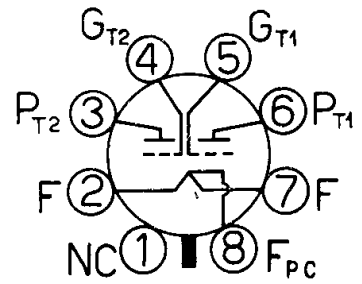

8L

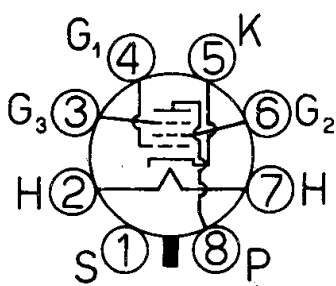

8N

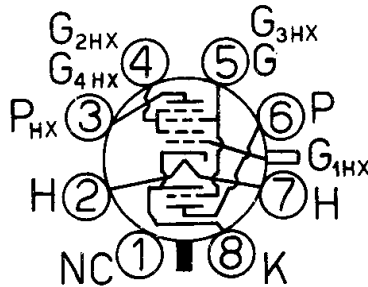

8O

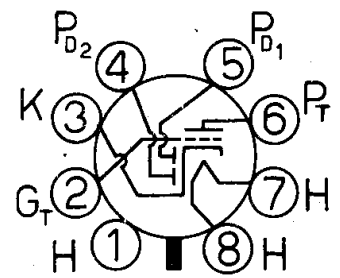

8Q

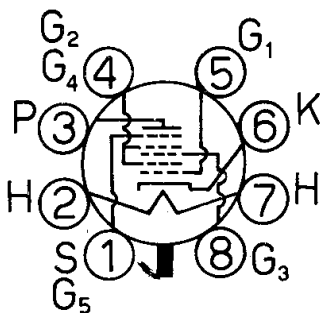

8R

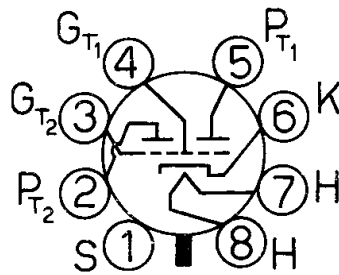

8S

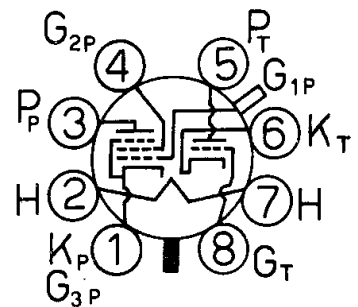

8T

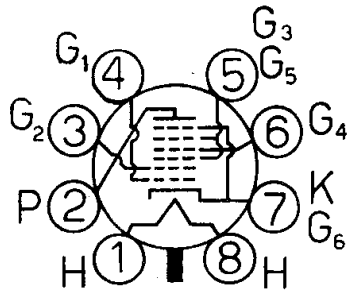

8U

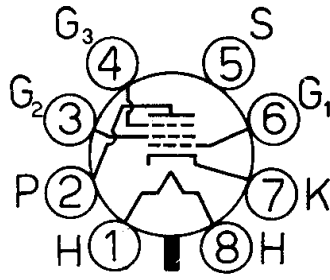

8V

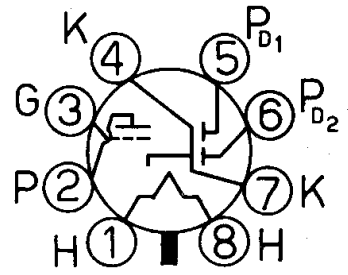

8W

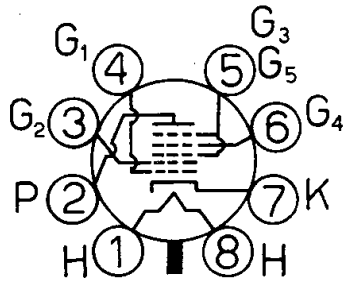

8X

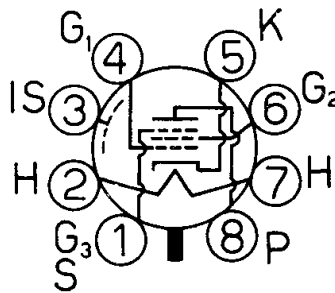

8Y

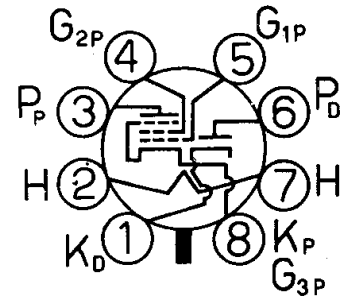

8Z

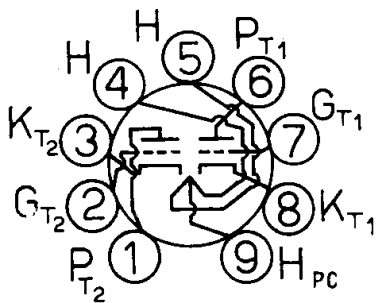

9A

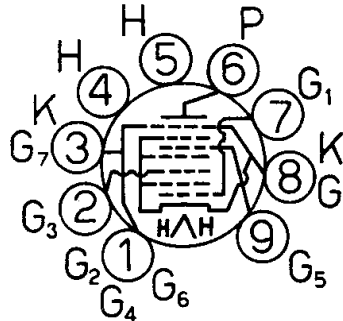

9AA

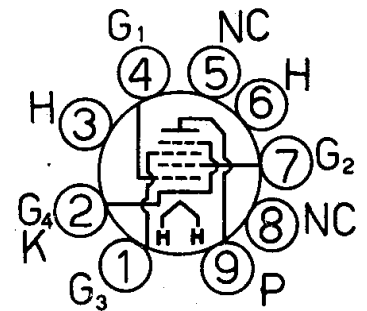

9AB

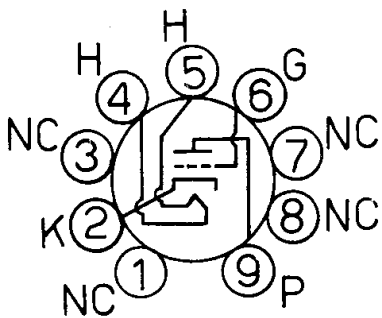

9AC

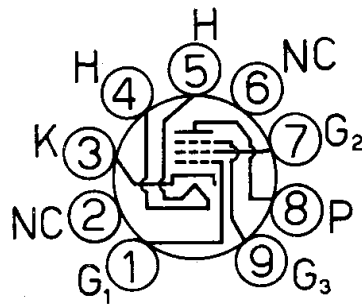

9AD

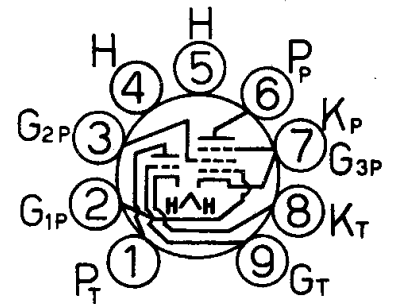

9AE

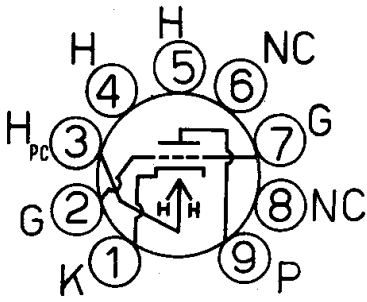

9AG

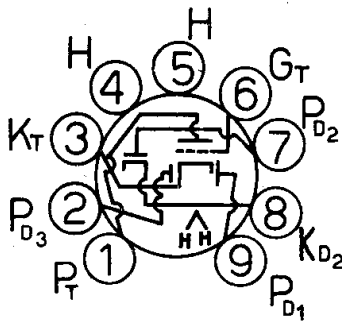

9AH

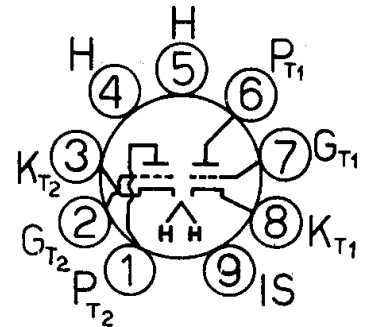

9AJ

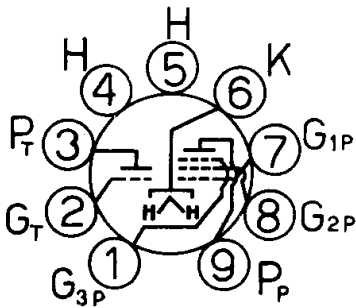

9AK

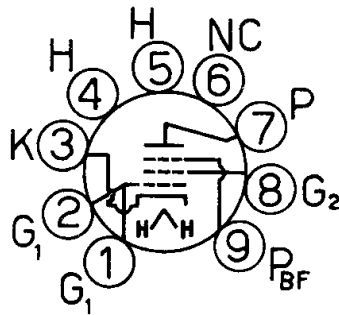

9AM

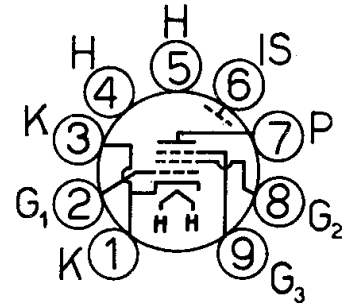

9AQ

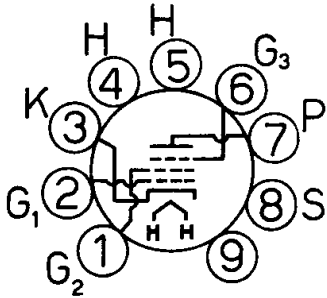

9AR

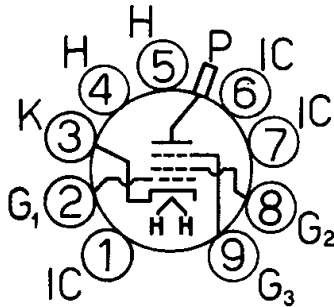

9AS

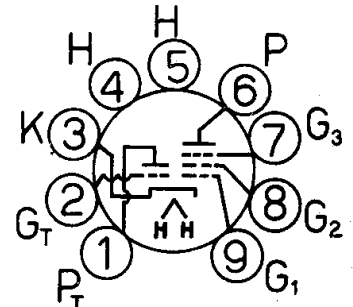

9AT

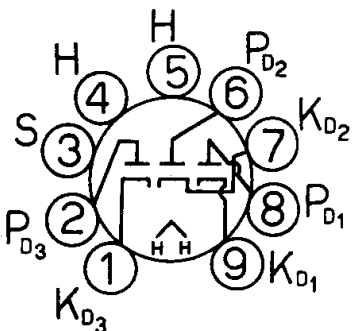

9AX

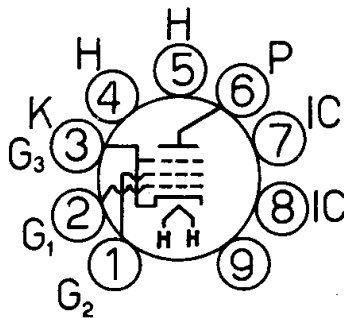

9AZ

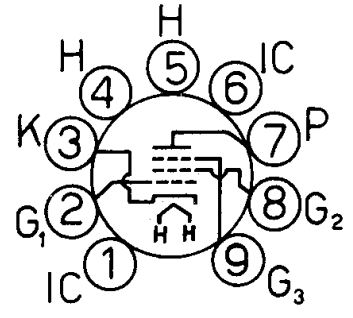

9BA

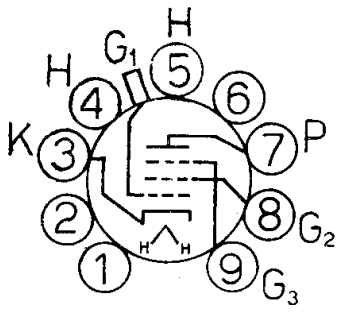

9BB

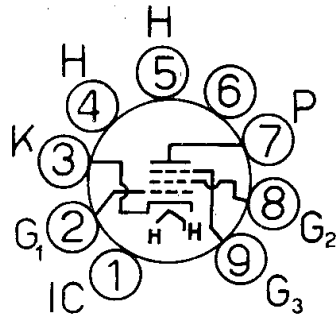

9BC

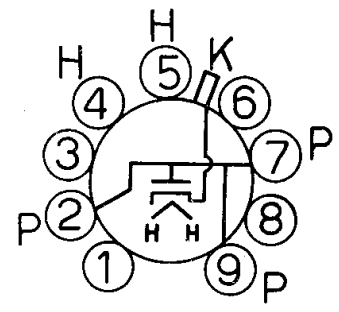

9BD

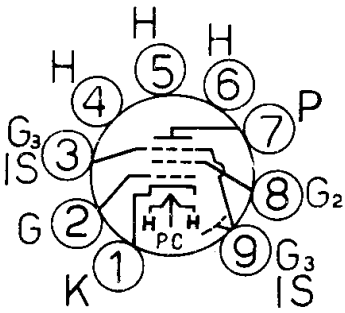

9BF

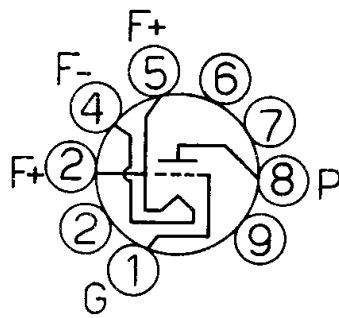

9BG

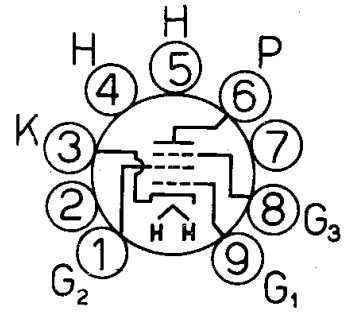

9BJ

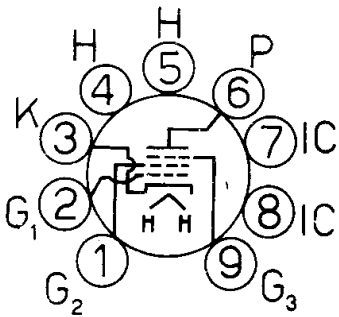

9BK

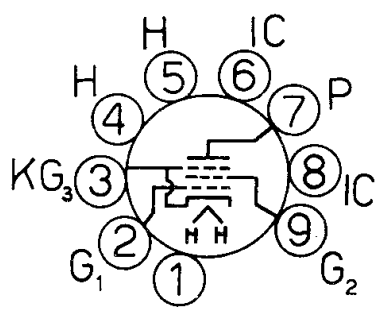

9BL

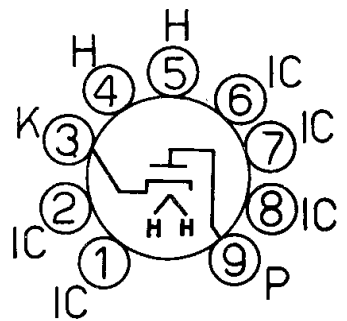

9BM

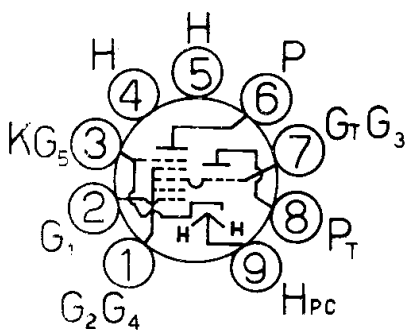

9BP

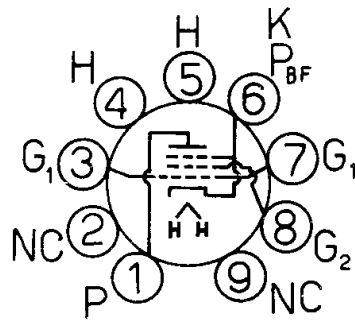

9BQ

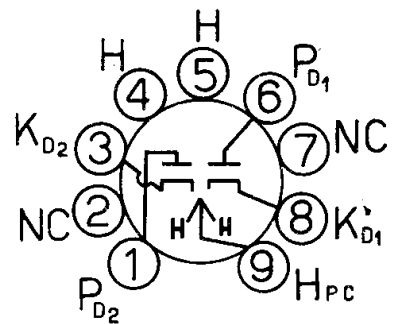

9BS

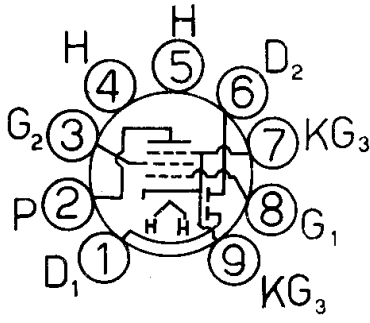

9BU

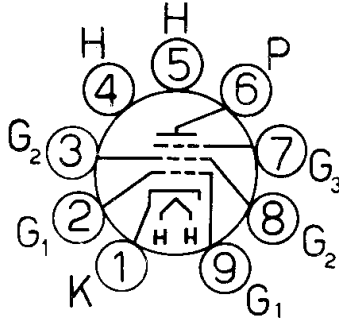

9BV

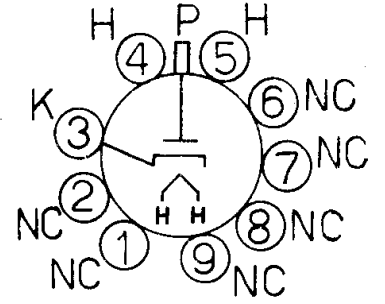

9BW

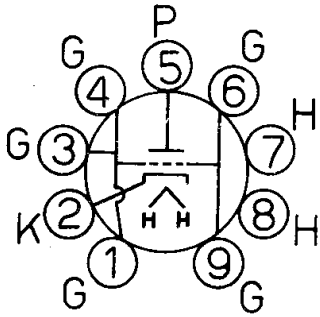

9BX

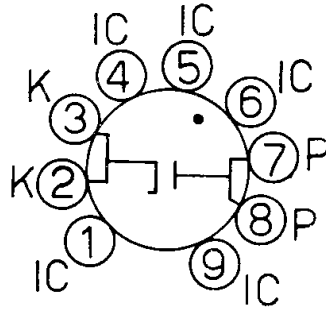

9BY

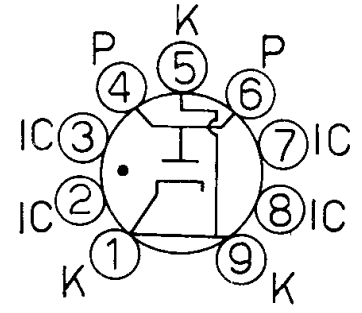

9BZ

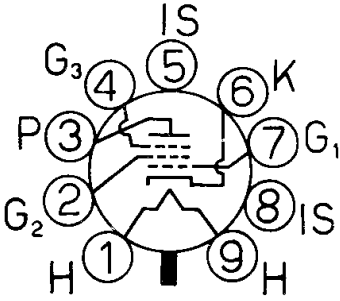

9C

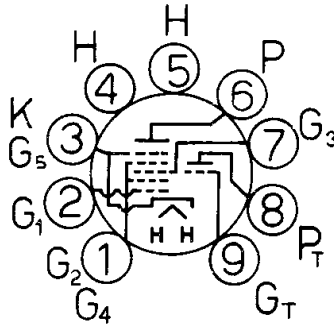

9CA

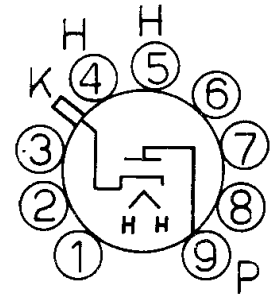

9CB

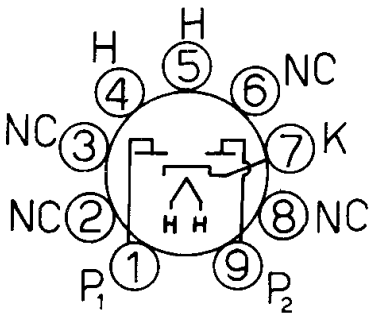

9CD

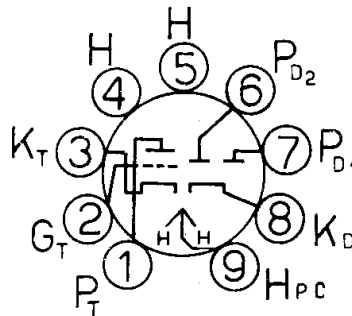

9CF

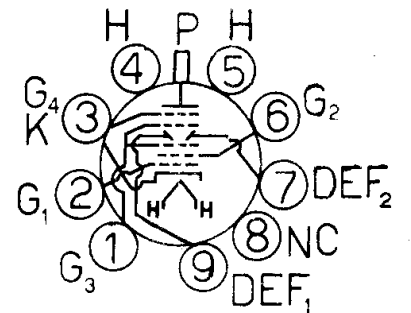

9CG

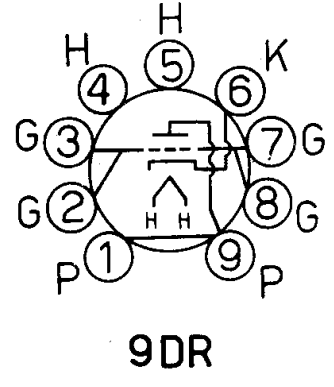
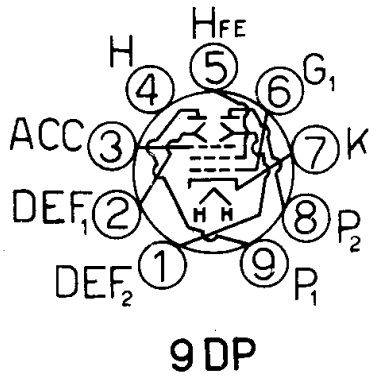
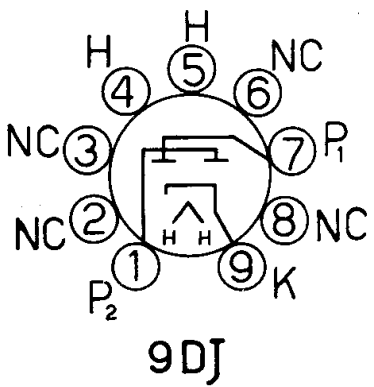
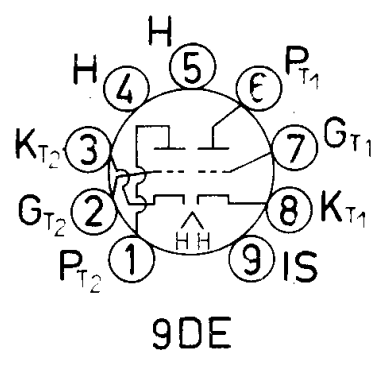
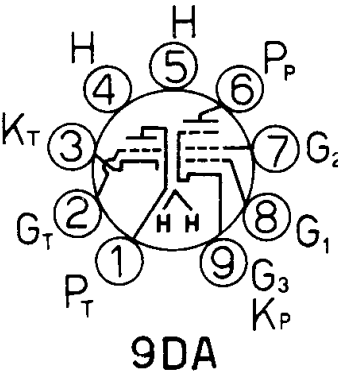
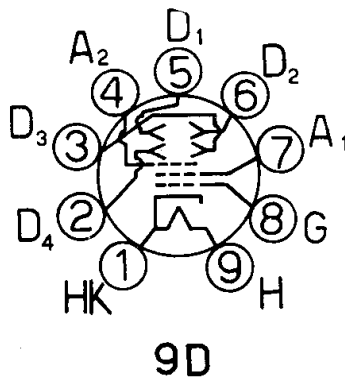
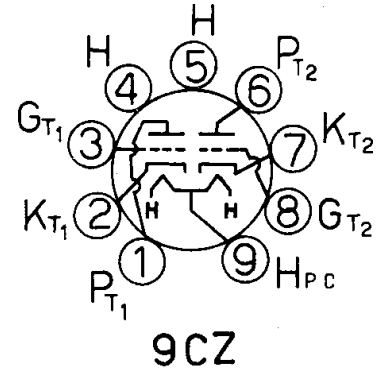
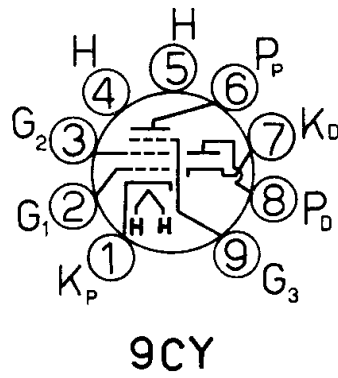
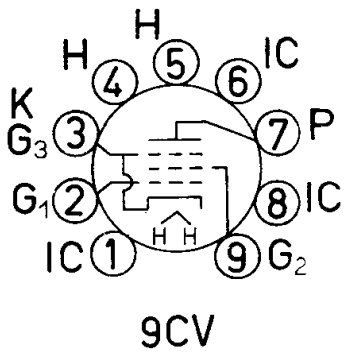
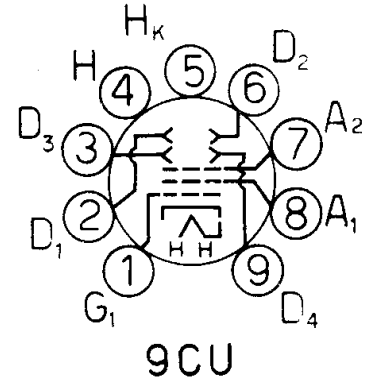
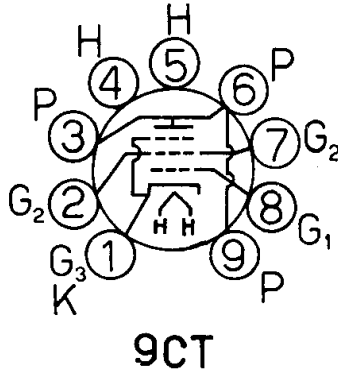
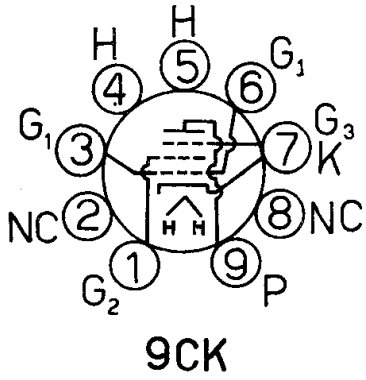

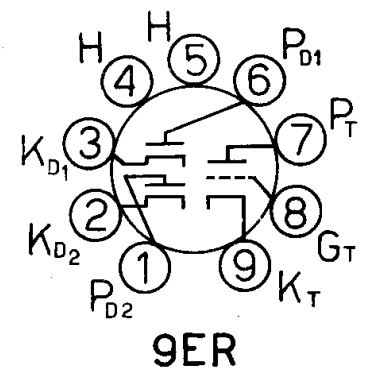
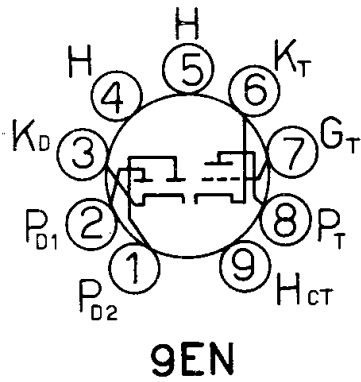
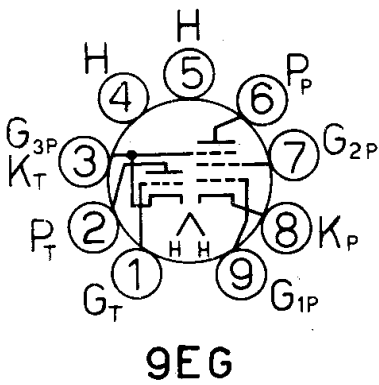
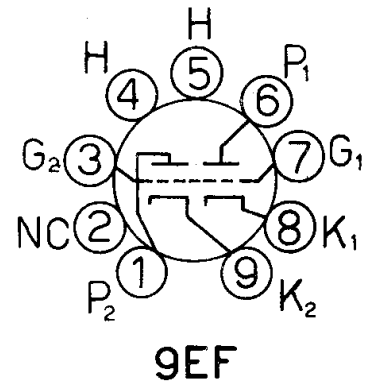
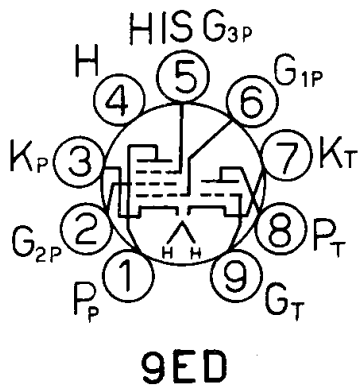
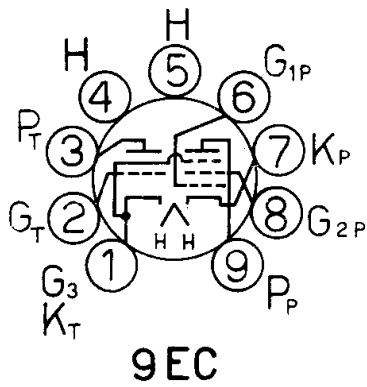
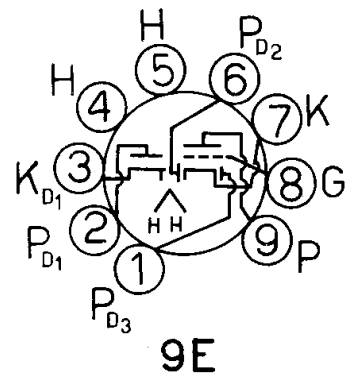
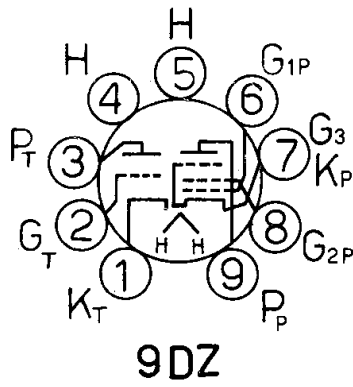
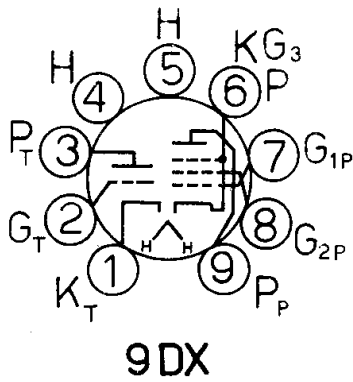
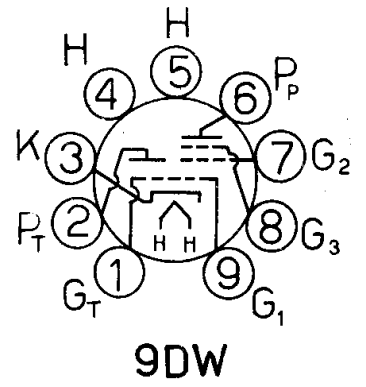
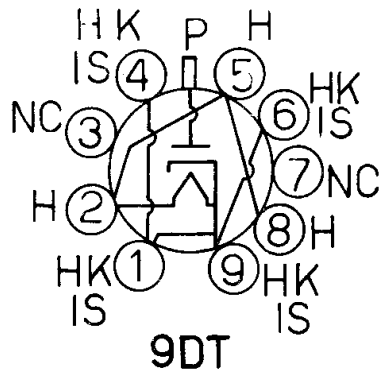
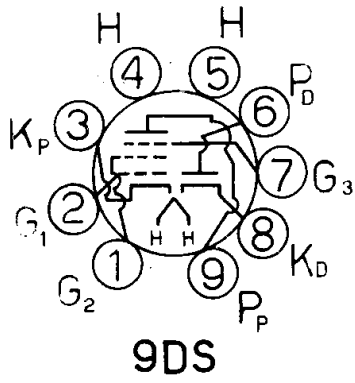

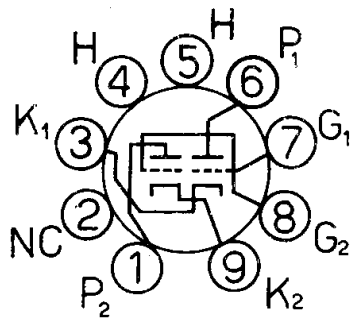

9ES

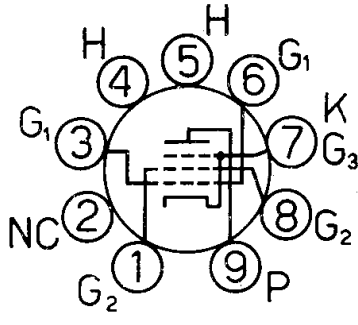

9EU

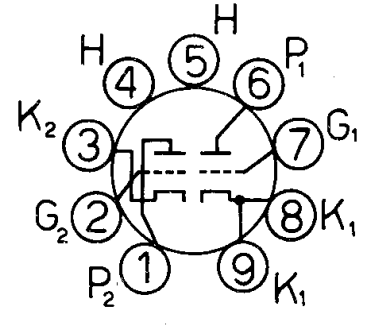

9EW

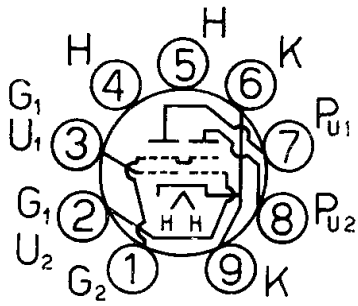

9F

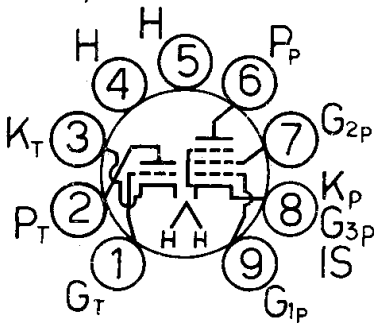

9FA

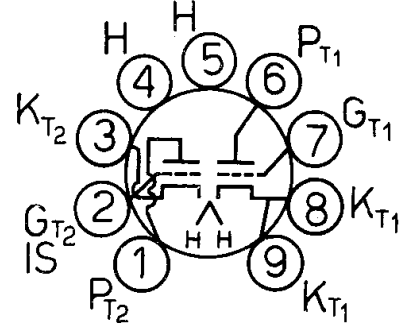

9FC

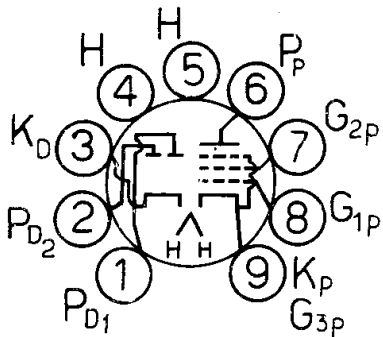

9FE

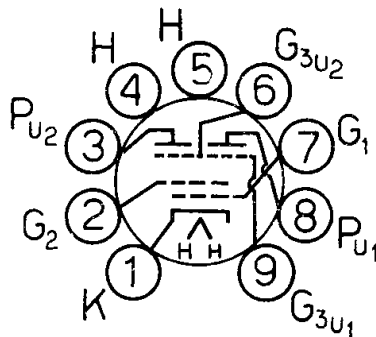

9FG

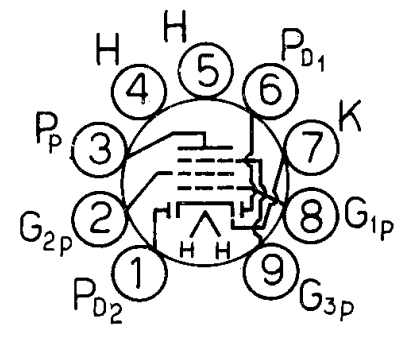

9FH

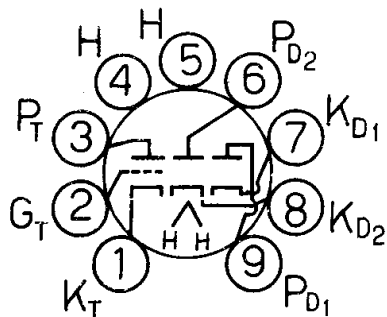

9FJ

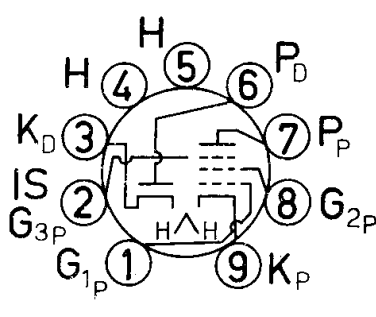

9FN

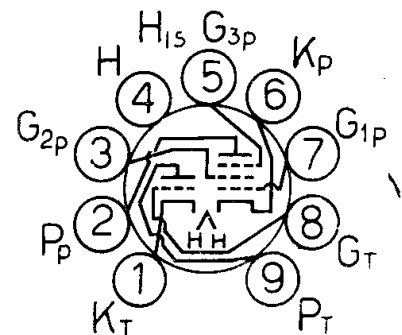

9FT

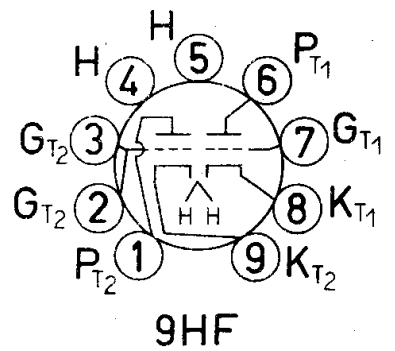
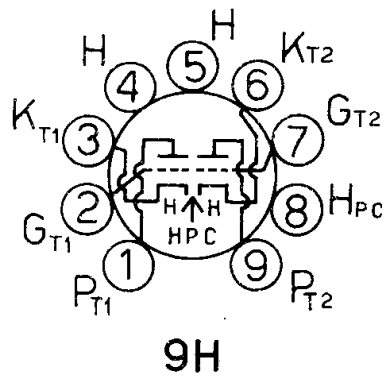
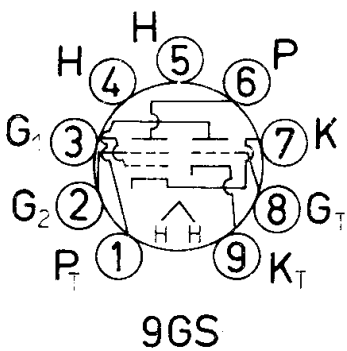
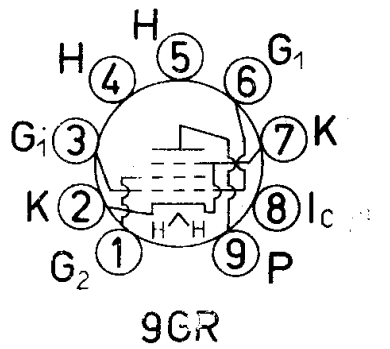
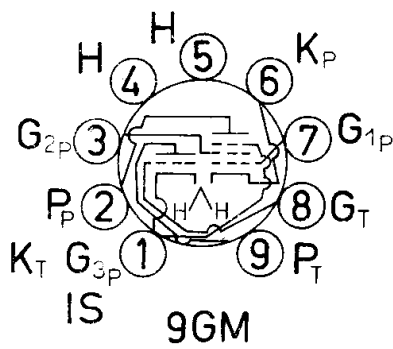
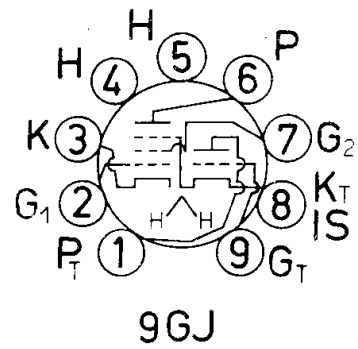
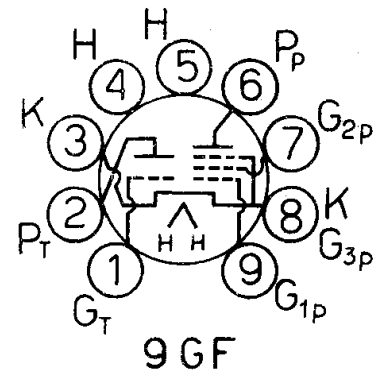
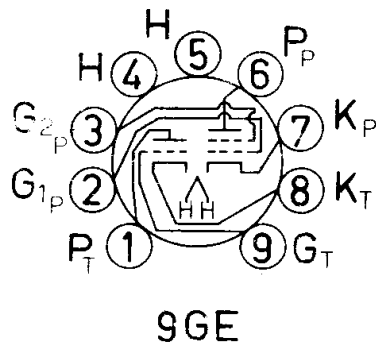
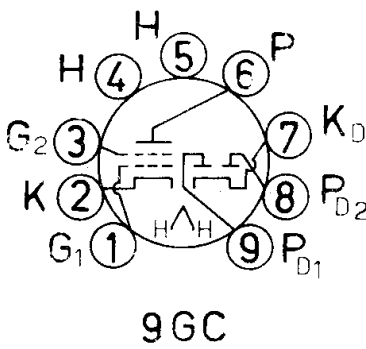
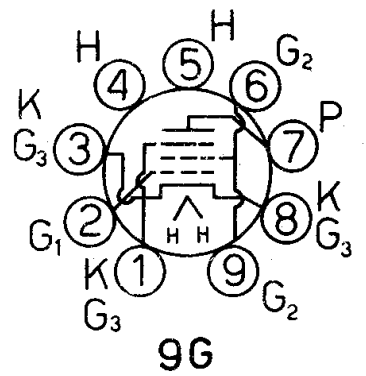
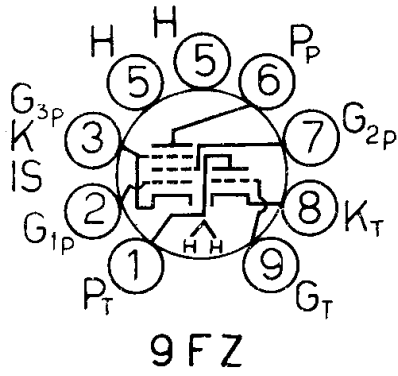
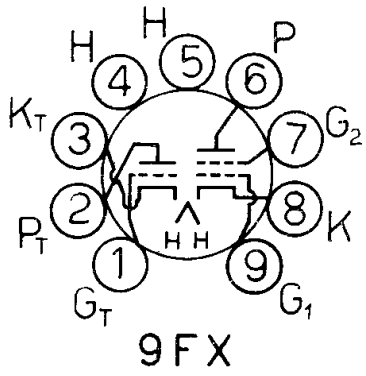

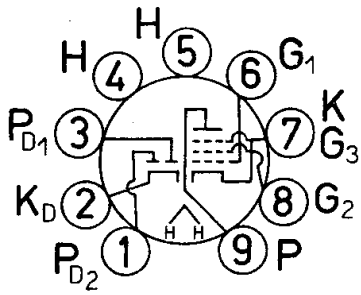

9HK

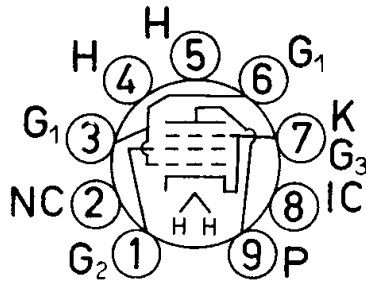

9HN

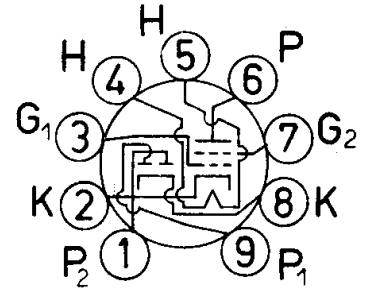

9HR

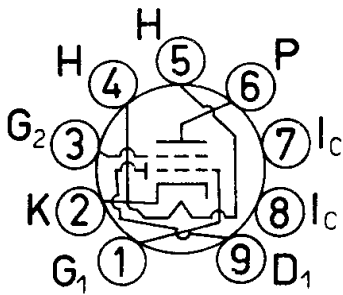

9HV

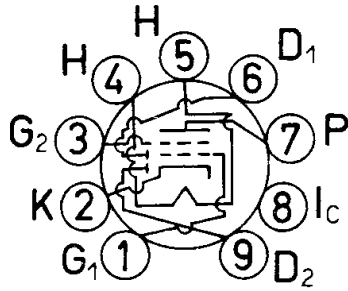

9HZ

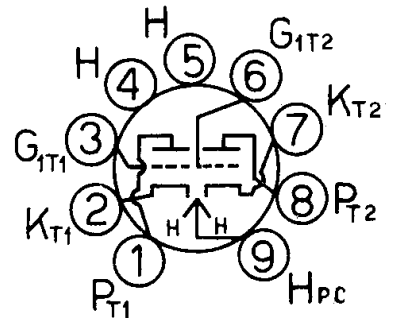

9J

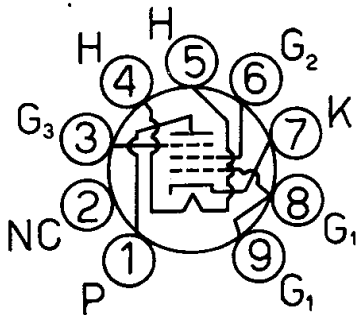

9K

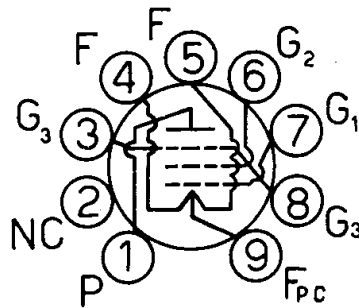

9L

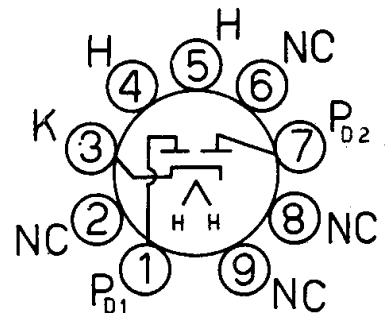

9M

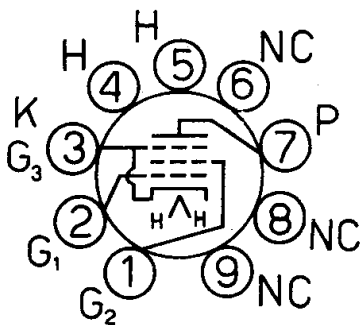

9N

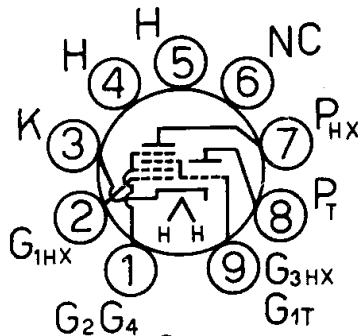

9Q

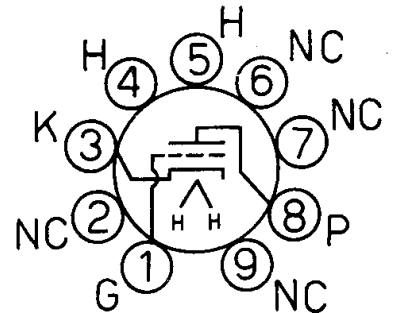

9R

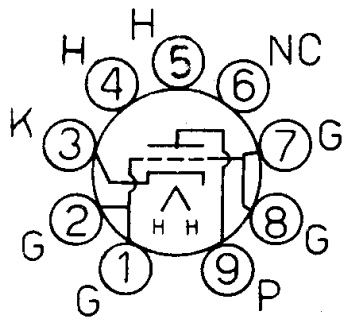

9S

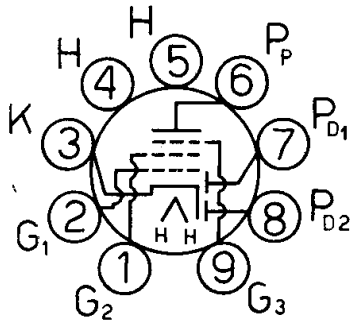

9T

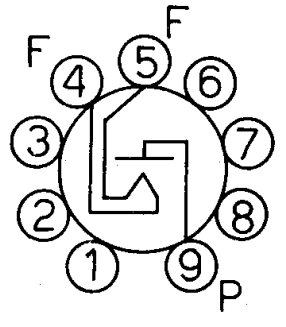

9U

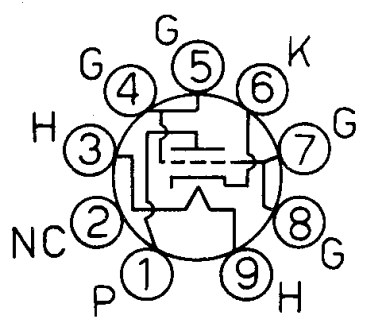

9V

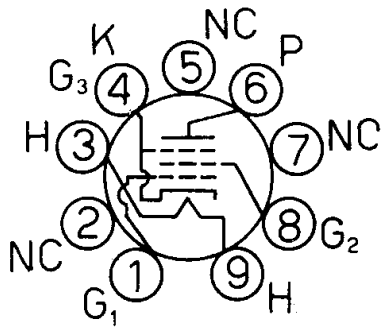

9X

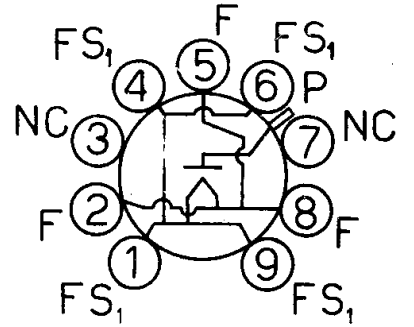

9Y

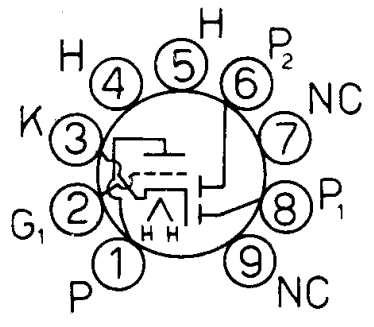

9Z

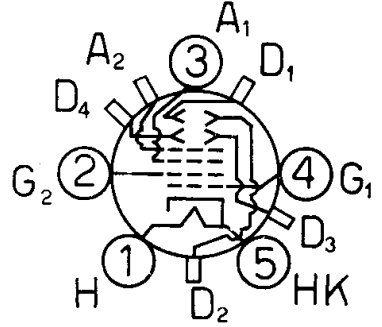

9I2

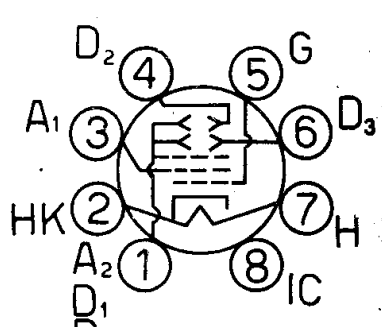

9I3

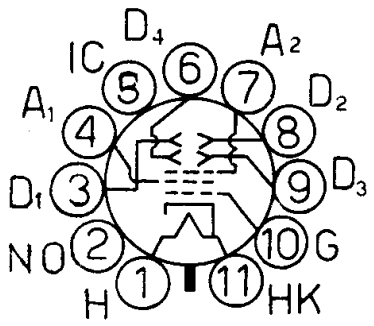

11A

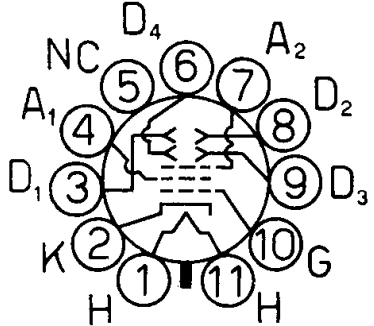

11B

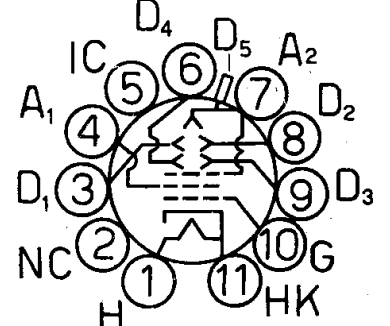

11C

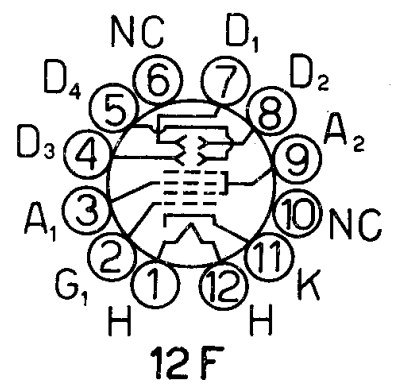
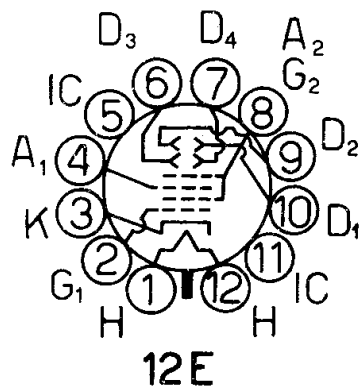
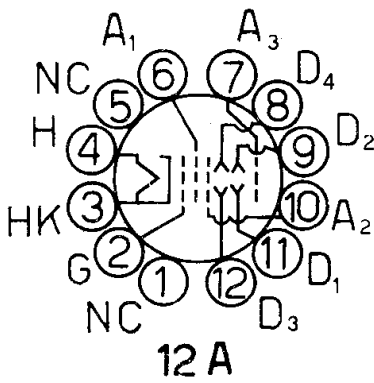
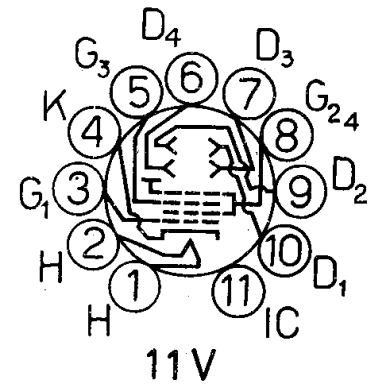
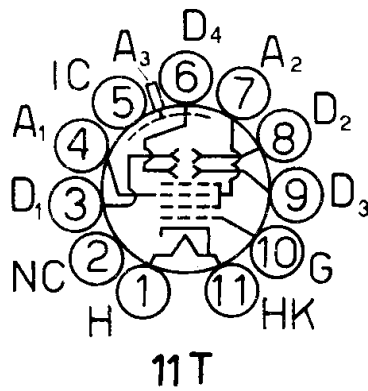
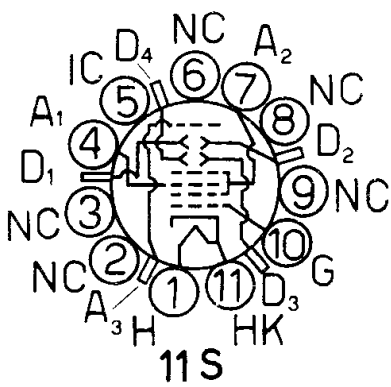
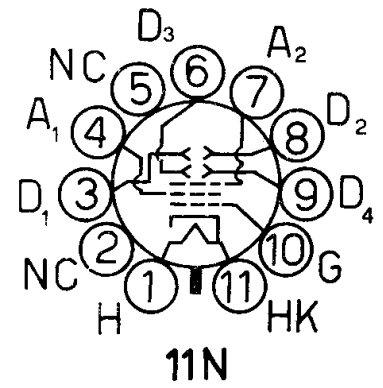
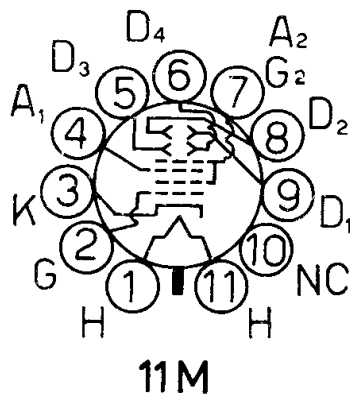
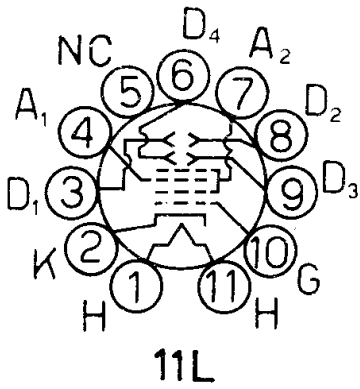
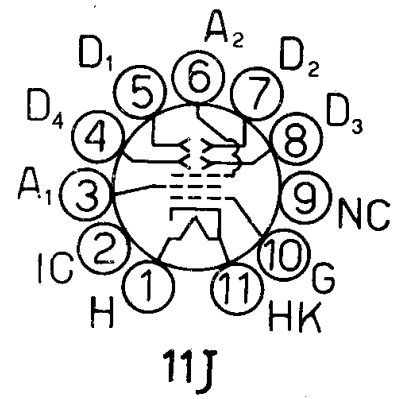
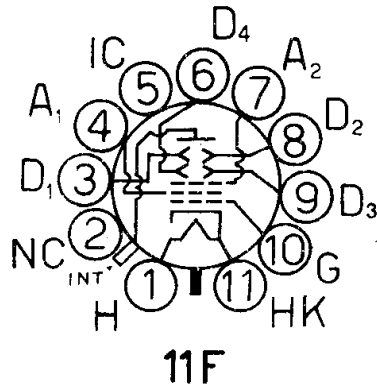
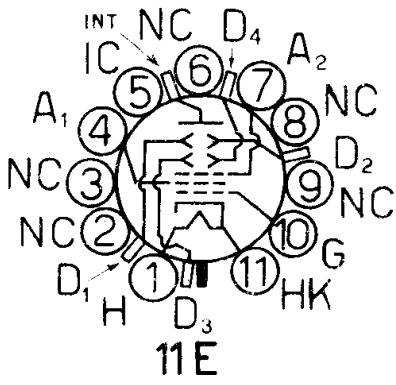

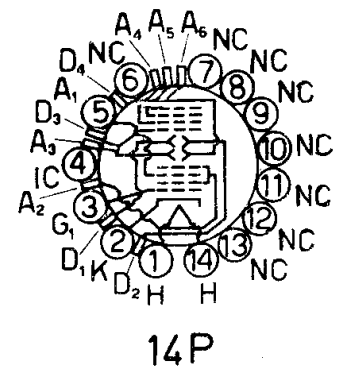
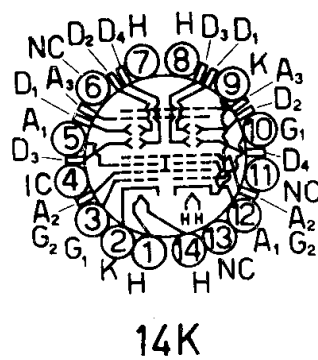
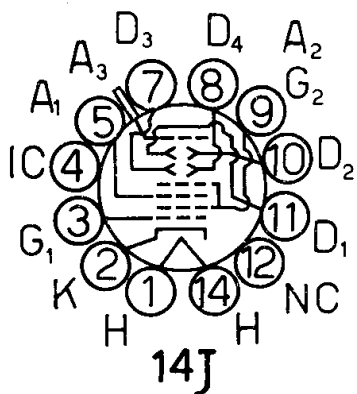
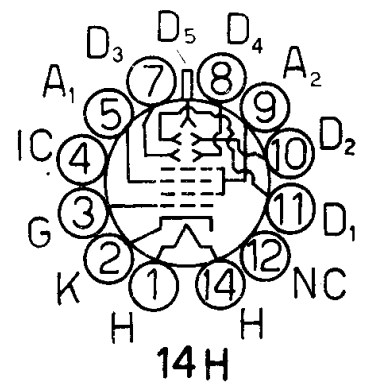
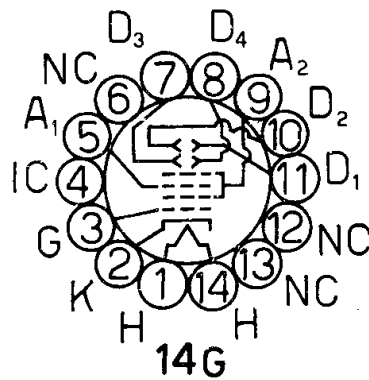
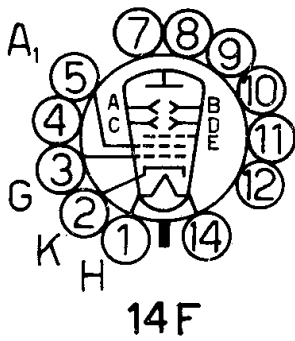
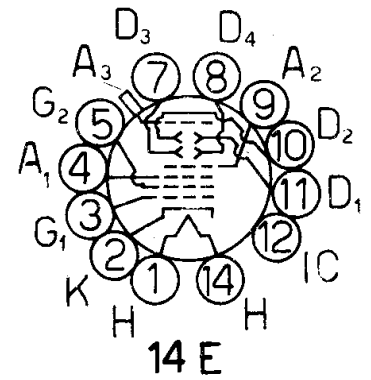
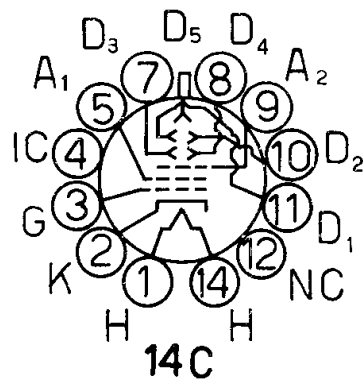
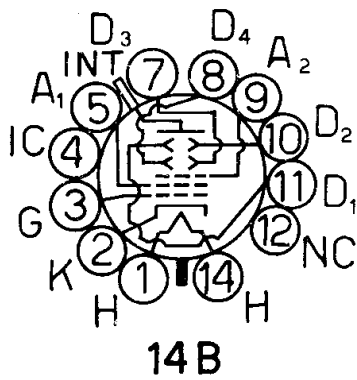
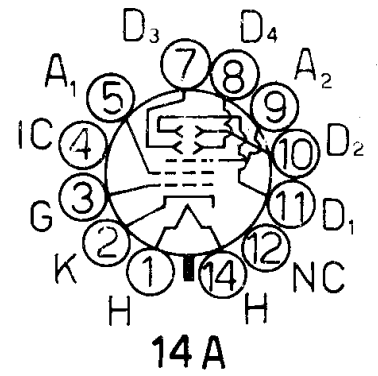
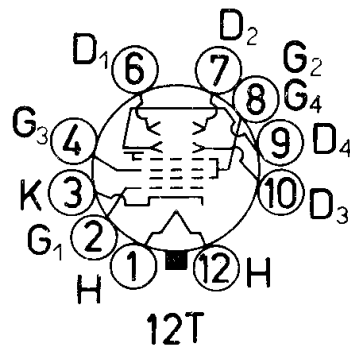
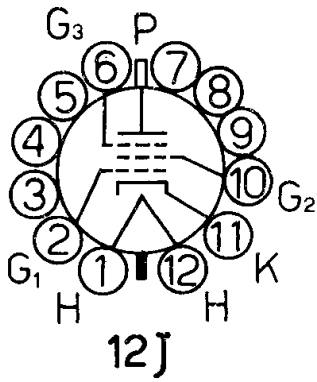

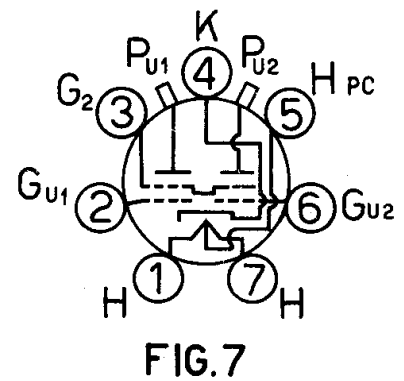
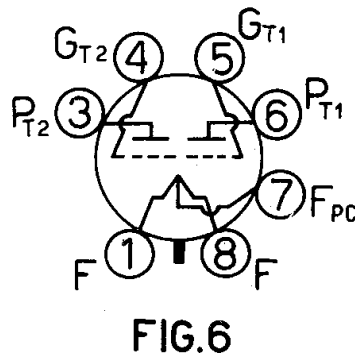
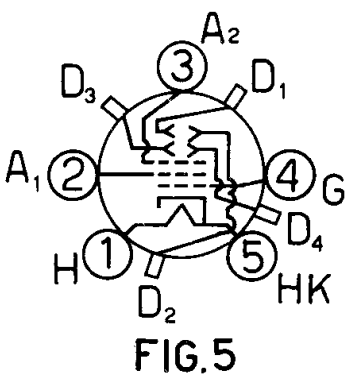
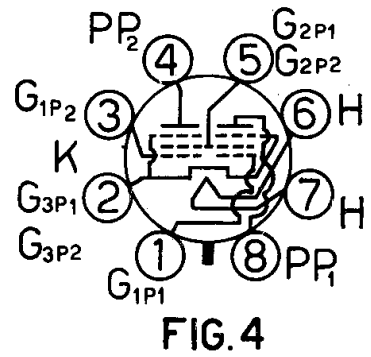
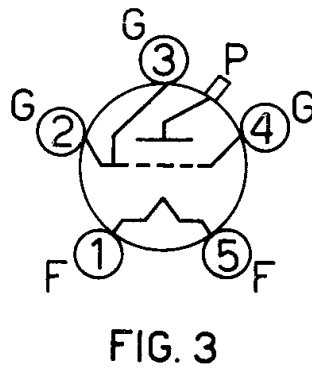
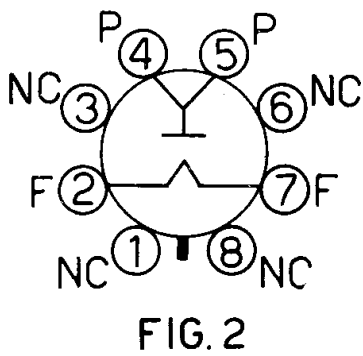
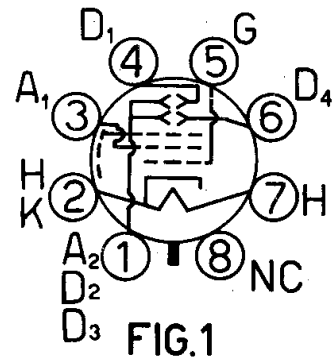
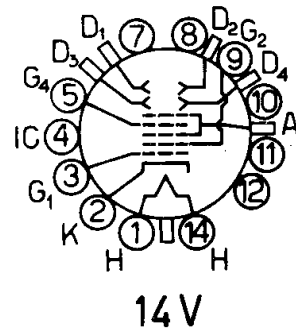
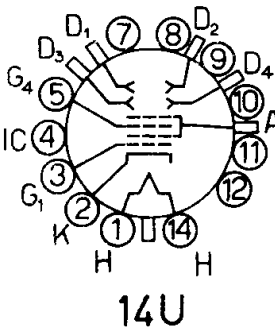
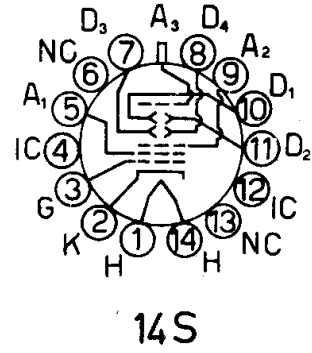
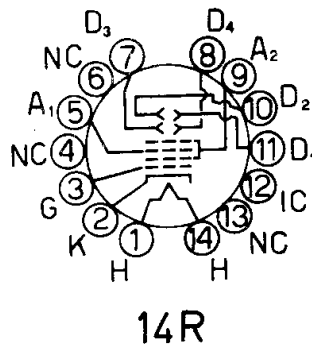
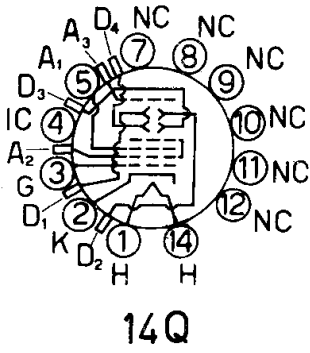

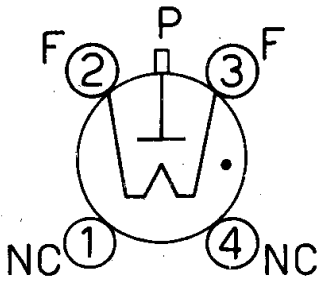

FIG. 8

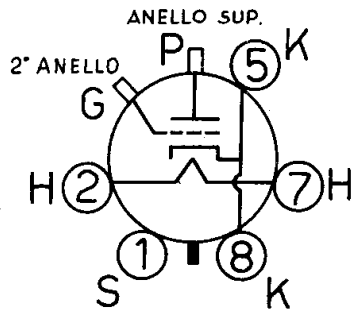

FIG. 9

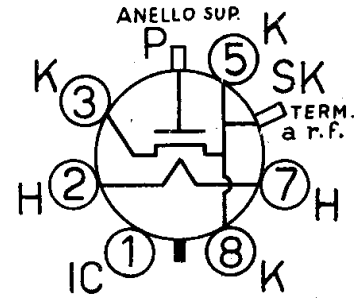

FIG. 10

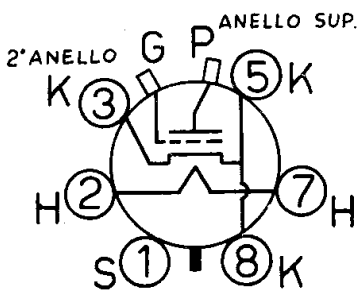

FIG. 11

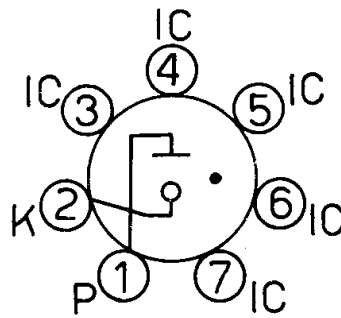

FIG. 12

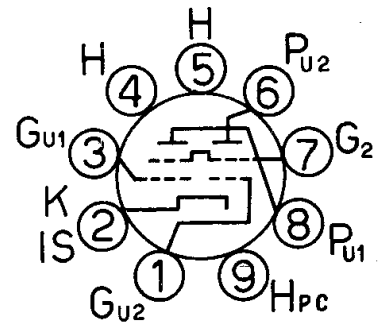

FIG. 13

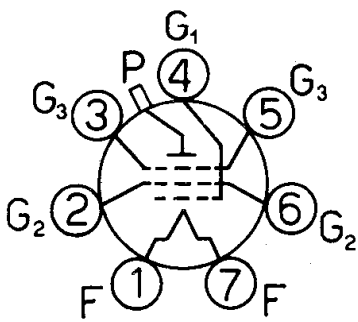

FIG. 14

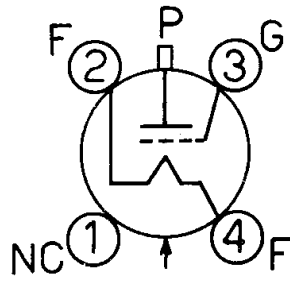

FIG. 15

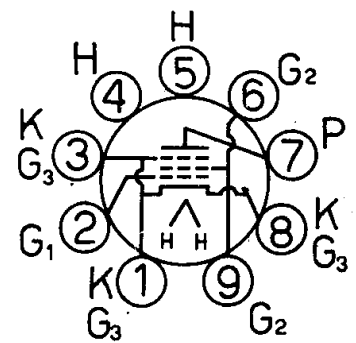

FIG. 16

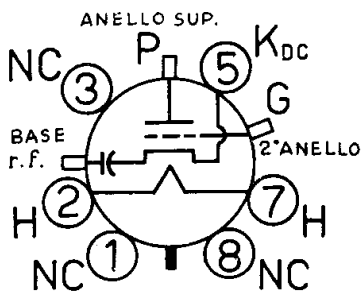

FIG. 17

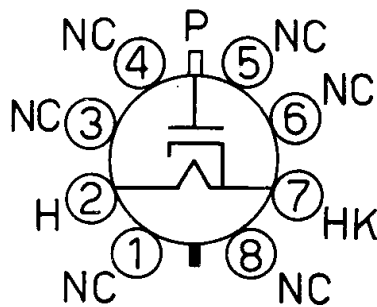

FIG. 18

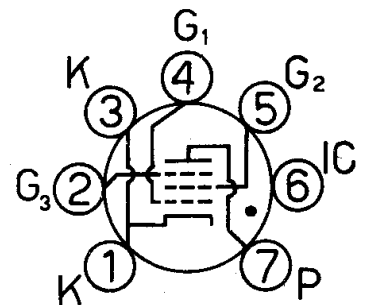

FIG. 19

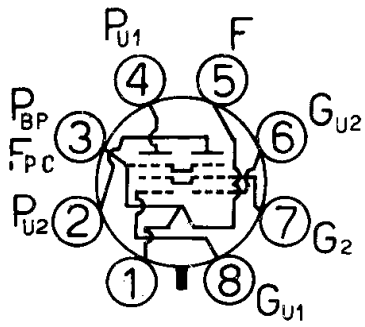

FIG. 20

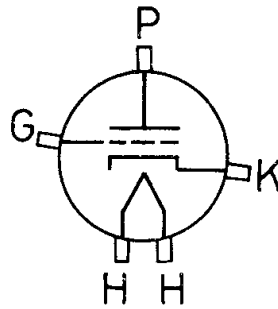

FIG. 21

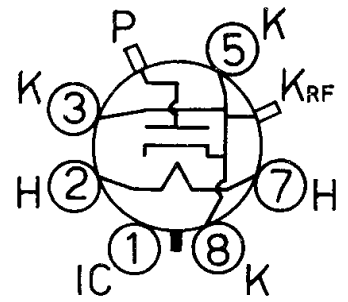

FIG. 22

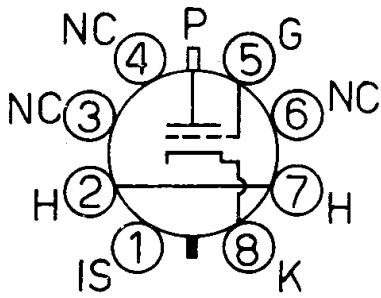

FIG. 23

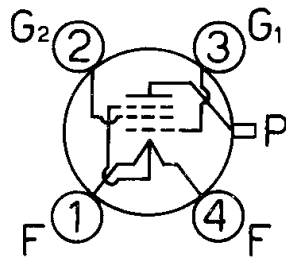

FIG. 24

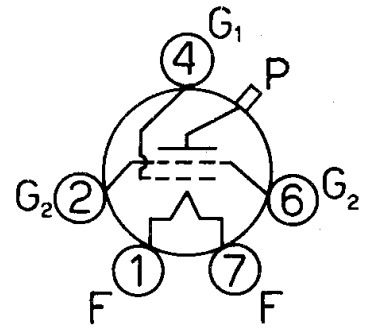

FIG. 25

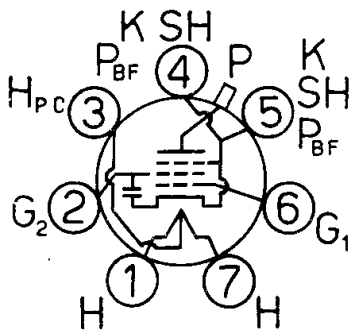

FIG. 26

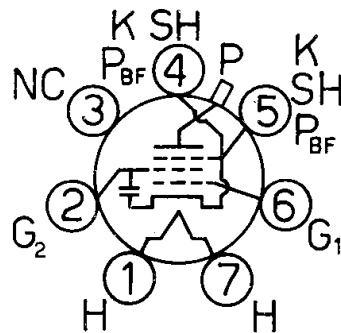

FIG. 27

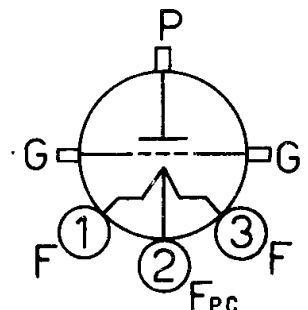

FIG. 28

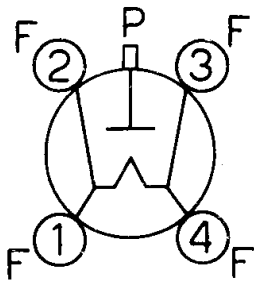

FIG. 29

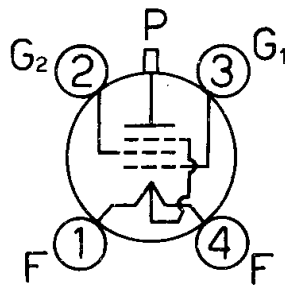

FIG. 30

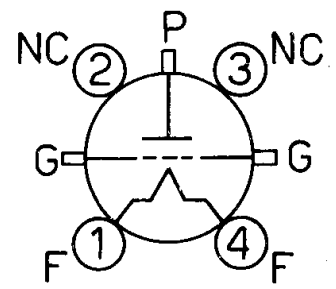

FIG. 31

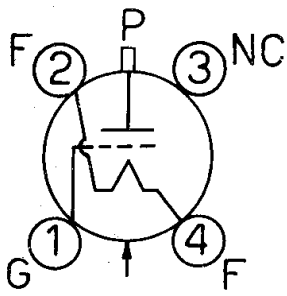

FIG.32

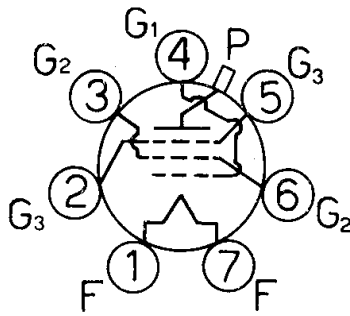

FIG.33

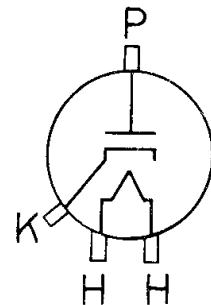

FIG.34

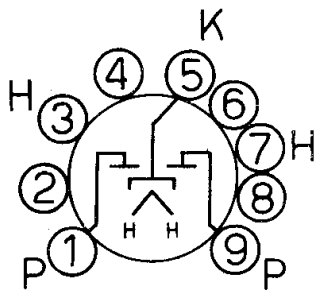

FIG.35

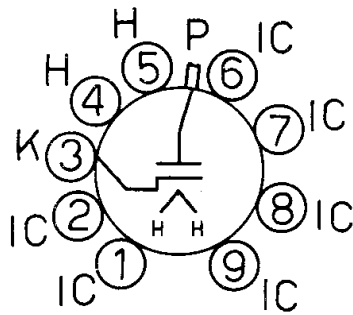

FIG.36

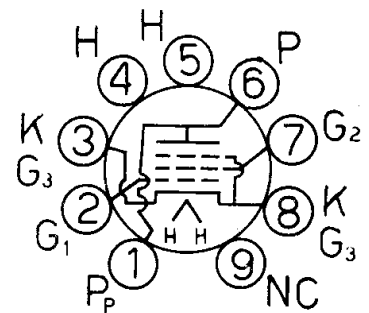

FIG.37

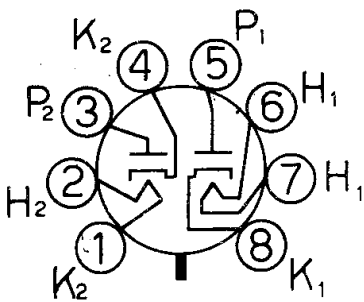

FIG.38

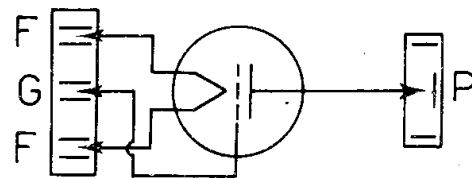

FIG.39

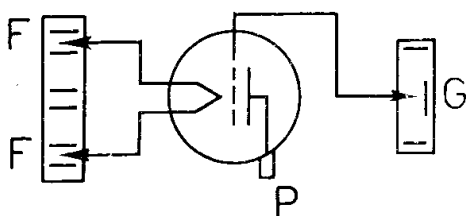

FIG.40

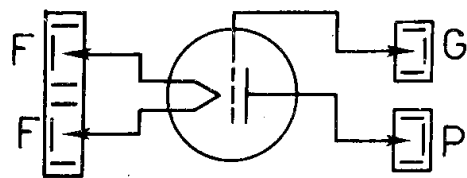

FIG.41

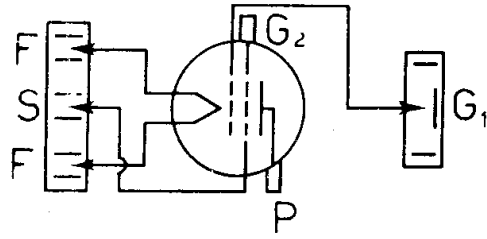

FIG. 42

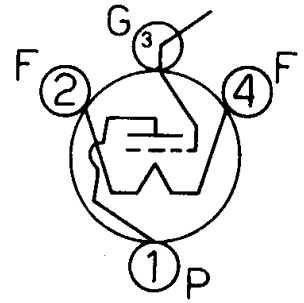

FIG. 43

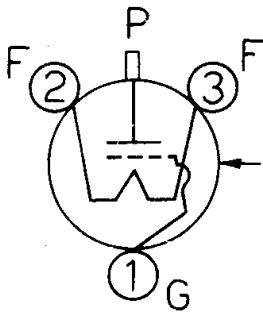

FIG. 44

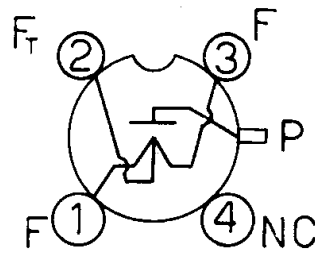

FIG. 45

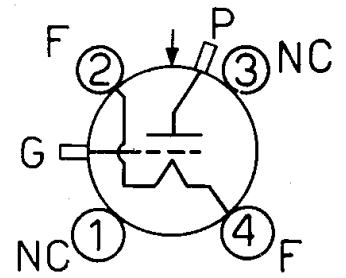

FIG. 46

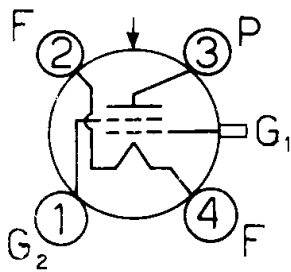

FIG. 47

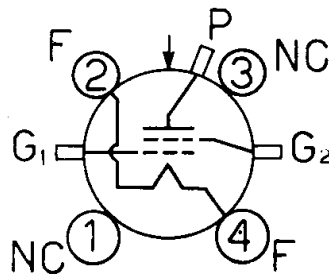

FIG. 48

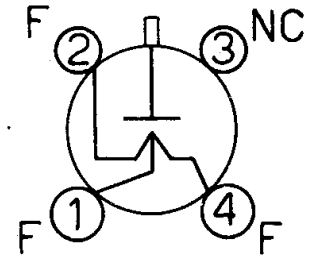

FIG. 49

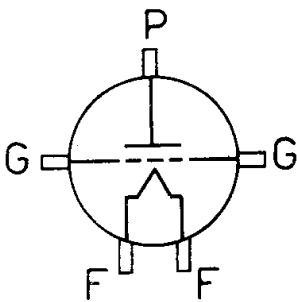

FIG. 50

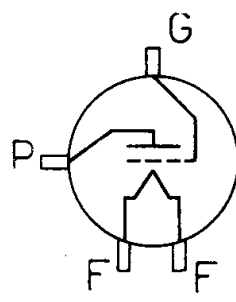

FIG. 51

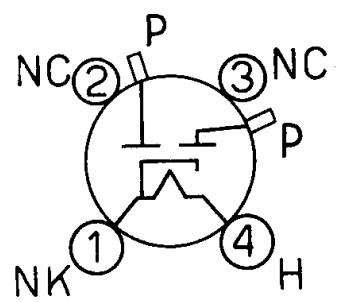

FIG. 52

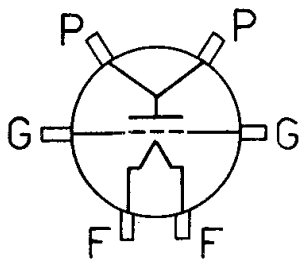

FIG. 53

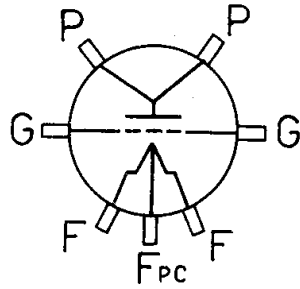

FIG. 54

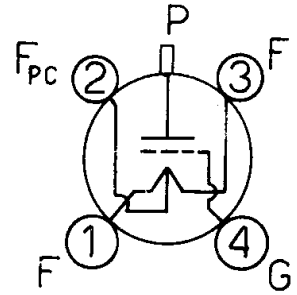

FIG. 55

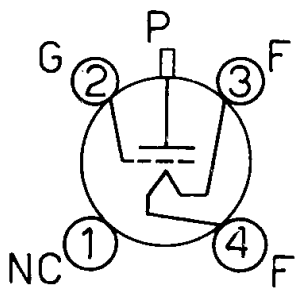

FIG. 56

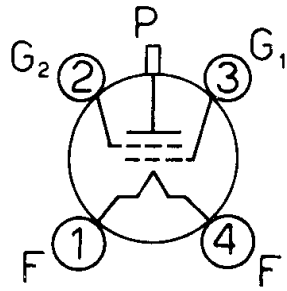

FIG. 57

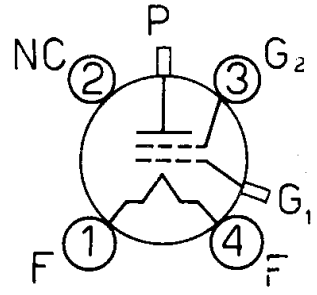

FIG. 58

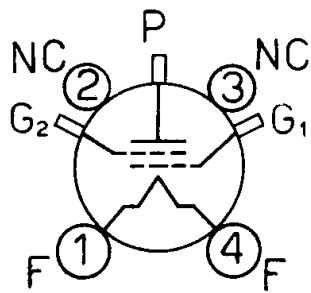

FIG. 59

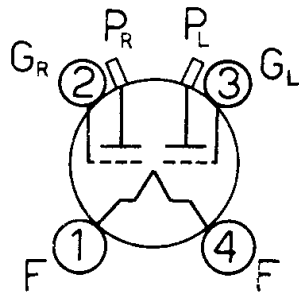

FIG. 60

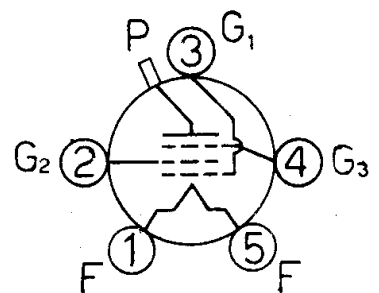

FIG. 61

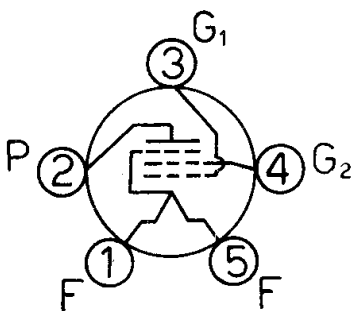

FIG. 62

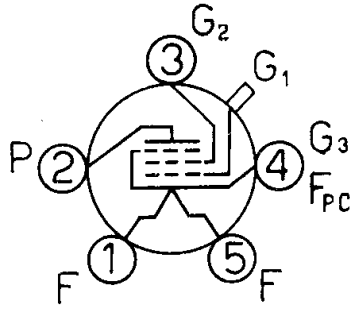

FIG. 63

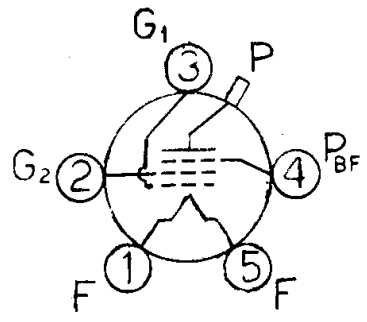

FIG. 64

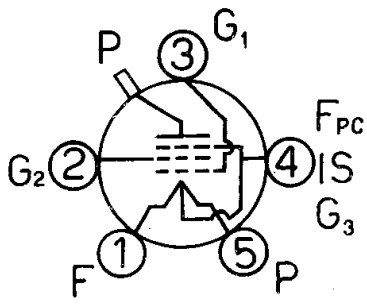

FIG. 65

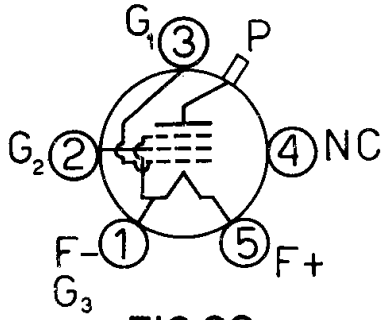

FIG. 66

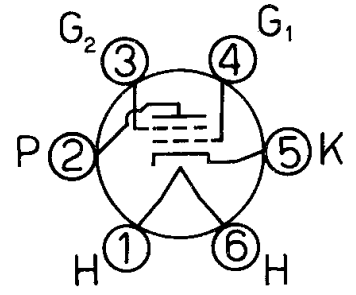

FIG. 67

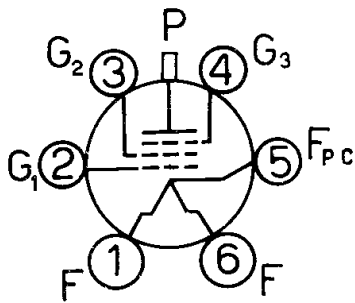

FIG. 68

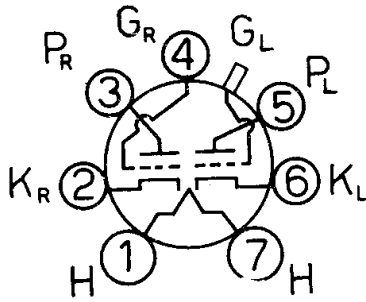

FIG. 69

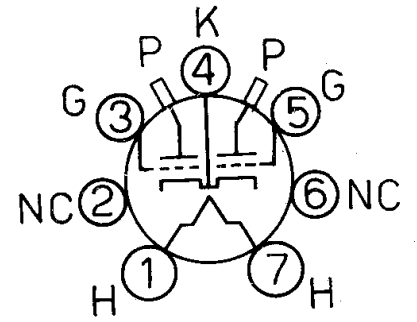

FIG. 70

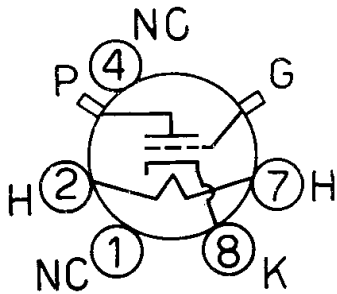

FIG. 71

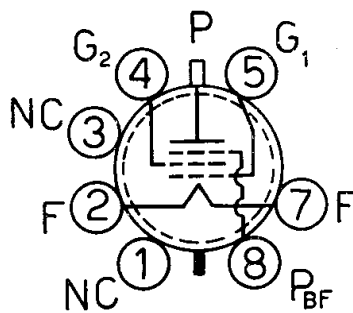

FIG. 72

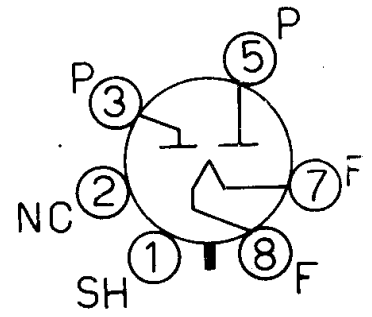

FIG. 73

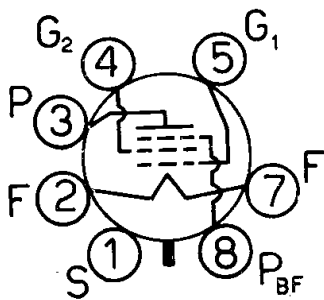

FIG. 74

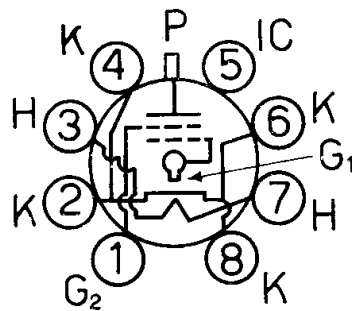

FIG. 75

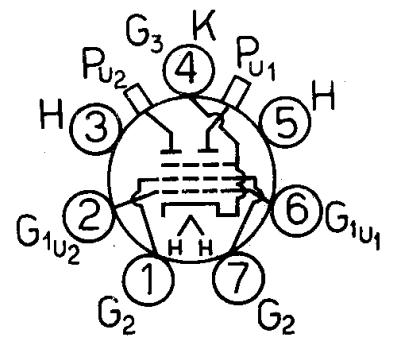

FIG. 76

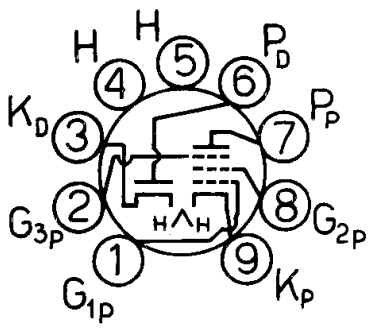

FIG. 77

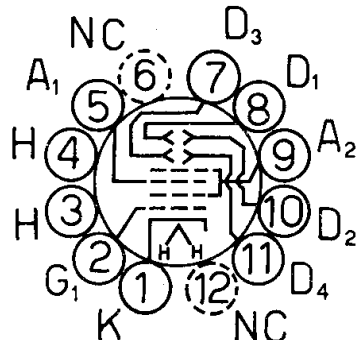

FIG. 78

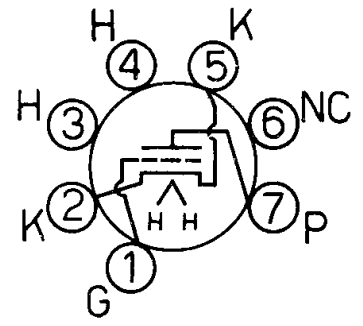

FIG. 79

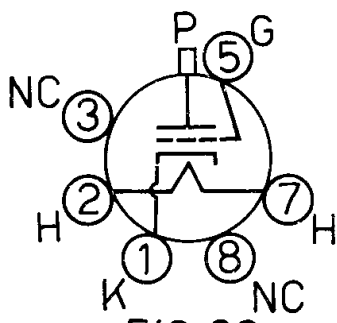

FIG. 80

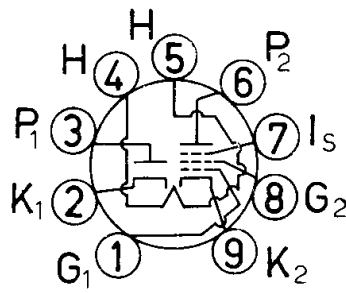

FIG. 81

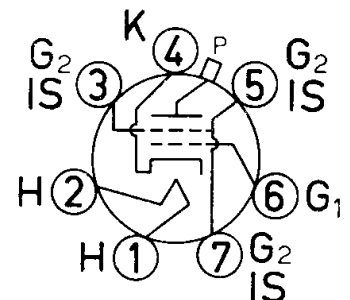

FIG. 82

Indice dei tubi elettronici

Tipo	Zoccolo	Pag.	Tipo	Zoccolo	Pag.	Tipo	Zoccolo	Pag.	Tipo	Zoccolo	Pag.
00A	4D	—	1T4	6AR	XXI	3BP1-4-11	14A	XLVII	4CX1000A	—	XVII
01A	4D	—	1T5GT	6X	XXXV	3BP1-A	14G	XLVII	4D21	5BK	XVI
0A2	5B8	XX	1U4	6AR	XXI	3BU8	9FG	IL	4D22	fig. 26	XV
0A3	4AJ	XX	1U5	6BW	XXI	3BY6	7CH	IL	4D23	5BK	—
0A4G	4V	XX	1U6	7DC	XXI	3BZ6	7CM	IL	4D32	fig. 27	XV
0A5	fig. 19	XX	1-V	4G	XVIII	3C4	6BX	XXI	4DT6	7EN	IL
0B2	5BO	XX	1V2	9U	XVIII	3C5GT	7AQ	—	4E27	7BM	XV
0B3	4AJ	XX	1W4	5BZ	—	3C6	7BW	XXXVII	4E27A	7BM	XVI
0C3	4AJ	XX	1X2	9Y	—	3C22	fig. 17	VII	4X150A	fig. 75	XVI
0D3	4AJ	XX	1X2A	9Y	—	3C23	3G	—	4X150A	fig. 75	XVII
0G3	5BO	—	1X2B	9Y	—	3C24	2D	IV	4X150D	fig. 75	XVII
OY4	4BU	—	1Y2	4P	—	3C28	fig. 31	IV	4X150G	—	XVI
OZ4	4R	—	1Z2	7CB	—	3C34	3G	IV	4X250B	fig. 75	XVII
OZ4A	4R	—	2A3	4D	—	3CB6	7CM	IL	4-65A	fig. 25	XV
1	4G	—	2A4G	5S	—	3CE5	7CM	IL	4-125A	5BK	XVI
1A3	5AP	XXI	2A5	6B	—	3CF6	7CM	IL	4-250A	5BK	XVI
1A4P	4M	—	2A6	6G	—	3CP1	11C	XLVII	4-400A	5BK	XVII
1A4T	4K	—	2A7	7C	—	3CS6	7CH	IL	5A6	9L	—
1A5GT	6X	XXXV	2AF4	7DK	—	3D6	6BB	XXXV	5ABP1-7-11	14J	XLVII
1A6	6L	—	2AF4A	7DK	IL	3D23	fig. 30	—	5ADP1-7-11	14J	XLVII
1A7GT	7Z	XXXV	2AP1-11	11B	XLVII	3D24	fig. 75	XIV	5AJP1	fig. 78	XLVII
1AB5	5BF	—	2AP1-A	11L	XLVII	3DP1	14C	XLVII	5AM8	9CY	IL
1AB6	7DH	XXI	2B4	5A	—	3DP1A	14H	XLVII	5AMP1	14U	XLVII
1AC6	7DH	XXI	2B6	7J	—	3DP7	14H	XLVII	5AN8	9DA	IL
1AE4	6AR	XXI	2B7	7D	—	3DT6	7EN	IL	5AP1-4	11A	XLVII
1AF4	6AR	XXI	2B22	fig. 22	XXXII	3DX3	fig. 24	—	5AQP1	14G	XLVII
1AF5	6AU	XXI	2B25	3T	XVIII	3E5	6BX	XXI	5AQ5	7BZ	IL
1AH5	6AU	XXI	2BN4	7EG	IL	3E6	7CJ	XXXV	5AS4	5T	XVIII
1AJ4	6AR	XXI	2BP1-11	12E	XLVII	3E22	8BY	XIV	5AS5	9DS	IL
1AX2	9Y	—	2C4	5AS	—	3E29	7BP	XIV	5AS8	9DS	IL
1B3GT	3C	XVIII	2C21	7BH	—	3EP1	11N	XLVII	5AT8	9DW	IL
1B4	4M	—	2C22	4AM	XXXII	3FP7	14B	XLVII	5ATP1-11	14V	XLVII
1B5	6M	—	2C25	4D	—	3GP7A	14J	XLVII	5AU4	5T	XVIII
1B7GT	7Z	—	2C26A	4BB	—	3GP1-4-5-11	11A	XLVII	5AV8	9DZ	IL
1B8GT	8AW	—	2C34	fig. 70	IV	3GP1A	11N	XLVII	5AW4	5T	XVIII
1C3	5CF	XXI	2C36	fig. 21	III	3GP4A	11N	XLVII	5AX4GT	5T	—
1C5GT	6X	—	2C37	fig. 21	III	3JP1-2-4	14J	XLVII	5AZ4	5T	—
1C6	6L	—	2C39	—	VII	3JP1A-7A	14J	XLVII	5B8	9EC	IL
1C7G	7Z	—	2C39WA	—	IL	3JP7-11-12	14J	XLVII	5BE8	9EG	XXII
1C21	4V	—	2C40	fig. 11	III	3JP11A	14J	—	5BK7A	9AJ	IL
1D5GP	5Y	—	2C43	fig. 11	IV	3KP1-4-11	11M	XLVII	5BP1	11A	XLVII
1D5GT	5R	—	2C51	8CJ	XXI	3LE4	6BA	—	5BP1A	11N	XLVII
1D7G	7Z	—	2C52	8BD	XXXVI	3LF4	6BB	IL	5BP7A	11N	XLVII
1D8GT	8AJ	—	2D21	7BN	XX	3MP1	12F	XLVII	5BQ7A	9AJ	IL
1DP1-4-7-11	9CU	XLVII	2E5	6R	—	3Q4	7BA	XXI	5BR8	9FA	IL
1E3	9BG	XXI	2E22	5J	XIV	3Q5GT	7AP	XXXVII	5BT8	9FE	IL
1E4G	5S	—	2E24	7CL	XII	3QP1	9D	XLVII	5BZ7	9AJ	IL
1E5GP	5Y	—	2E25	5BJ	XIII	3RP1	12E	XLVII	5CG8	9GF	IL
1E7G	8C	—	2E26	7CK	XIII	3RP1A	12E	XLVII	5CL8	9FX	IL
1EP1	11V	XLVII	2E30	7CQ	XII	3S4	7BA	XXI	5CM8	9FZ	IL
1F4	5K	—	2E30	7CQ	XXI	3SP1-4-7	12E	XLVII	5CP7A	14J	—
1F5G	6X	—	2G5	6R	—	3UP1	12F	XLVII	5CP1-11	14B	—
1F6	6W	—	2S, 4S	5D	—	3V4	6BX	IL	5CP1A	14J	XLVII
1F7G	7AD	—	2T4	7TK	IL	3WP1-2-11	12T	XLVII	5CP1B-11B	14J	XLVII
1G3GT	3C	XVIII	2V2	8Fv	—	3-25A3	3G	IV	5CP7A	14J	XLVII
1G4GT	5S	—	2V3G	4Y	—	3-25D3	2D	IV	5CP11A	14J	XLVII
1G5G	6X	—	2W3	4X	—	3-50A4	3G	V	5CP12	14J	XLVII
1G6GT	7AB	XXXV	2X2	4AB	—	3-50D4	2D	V	5D22	5BK	XVI
1H4G	5S	—	2X2-A	4AB	XVIII	3-50G2	2D	—	5GP1	11A	XLVII
1H5GT	5Z	XXXV	2Y2	4AE	XVIII	3-75A2	2D	VI	5HP1-4	11A	XLVII
1H6G	7AA	—	2Z2	4B	XVIII	3-75A3	2D	VI	5HP1A	11N	XLVIII
1J3	3C	XVIII	3A2	9DT	—	3-100A2	2D	VII	5J6	7BF	IL
1J5G	6X	—	3A3	8EZ	—	3-100A4	2D	VI	5JP1-11	11E	XLVIII
1J6GT	7AB	—	3A4	7BB	XII	3X100A5	—	VII	5JP1-4A	11S	XLVIII
1K3	3C	XVIII	3A4	7BB	XXI	3X-100A11	—	VII	5LP1-11	11F	XLVIII
1L4	6AR	XXI	3A5	7BC	III	3-150A2	4BC	VIII	5LP1A-4A	11T	XLVIII
1L6	7DC	XXI	3A5	7BC	XXI	3-150A3	4BC	VIII	5MP1-11	7AN	XLVIII
1LA4	5AD	—	3A8GT	8AS	—	3-200A3	fig. 2b	IX	5NP1-4	11A	XLVIII
1LA6	7AK	XXXV	3ACP1-7-11	14J	XLVII	3-250A2	2N	IX	5R4GY	5T	XVIII
1LB4	5AD	XXXV	3AF4A	7DK	IL	3-250A4	2N	IX	5R4GYA	5T	XVIII
1LB6	8AX	XXXV	3AL5	7BT	IL	3-300A2	4BC	X	5RP1-11	14F	XLVIII
1LC5	7AO	—	3AP1-4	7AN	XLVII	3-300A3	4BC	X	5RP1-4A	14P	XLVIII
1LC6	7AK	XXXV	3AP1-A	7CE	XLVII	4A6G	8L	XXXVII	5SP1-4	14K	XLVIII
1LD5	6AX	XXXV	3AU6	7BK	IL	4BC5	7BD	IL	5T4	5T	XVIII
1LE3	4AA	XXXV	3AV6	7BT	IL	4BC8	9AJ	IL	5T8	9E	IL
1LF3	4AA	IL	3B4	7CY	—	4BN6	7DF	IL	5U4G	5T	XVIII
1LG5	7AO	XXXV	3B5GT	7AP	—	4BQ7A	9AJ	IL	5U4GB	5T	XVIII
1LH4	5AG	IL	3B7	7AP	III	4BS8	9AJ	IL	5U4CB	5T	XVIII
1LN5	7AO	XXXV	3B7	7BE	XXXV	4BU8	9FG	IL	5U8	9AE	IL
1N5GT	5Y	XXXV	3B24	fig. 49	XVIII	4BX8	9AJ	IL	5UP1-11	12E	XLVIII
1N6G	7AM	—	3B25	4P	—	4BZ7	9AJ	IL	5V3	5T	XVIII
1P5GT	5Y	—	3B26	fig. 18	—	4BZ8	9AJ	IL	5V4G	5L	XVIII
1Q5GT	6AF	—	3B27	4P	—	4C32	2N	—	5V4GA	5L	IL
1R4	4AH	XXXV	3B28	4P	XVIII	4C34	2N	IX	5V6GT	7S	IL
1R5	7AT	XXI	3BA6	7CC	IL	4C36	fig. 31	—	5VP7	11N	XLVIII
1S4	7AV	XXI	3BC5	7BD	IL	4CB6	7CM	IL	5W4GT	5T	XVIII
1S5	6AU	XXI	3BE6	7BD	IL	4CE5	7BD	IL	5X3	4C	—
1SA6GT	6CA	—	3BN4	7EG	IL	4CX7	9FC	IL	5X4G	5Q	XVIII
1SB6GT	6CB	—	3BN6	7DF	IL	4CX-300A	—	XVII	5XP1	14P	XLVIII

C

Tipo	Zoccolo	Pag.	Tipo	Zoccolo	Pag.	Tipo	Zoccolo	Pag.	Tipo	Zoccolo	Pag.
5X8	9AK	IL	6AX4GT	4CG	—	6CD6G	5BT	XXXII	6L7	7T	XXX
5Y3G-GT	5T	XVIII	6AX5GT	6S	XVIII	6CD6GA	5BT	IL	6M5	7N	XXVI
5Y3WGT	5T	—	6AX6G	7Q	—	6CE5	7BD	XXV	6M6G	7S	—
5Y4G-GT	5Q	XVIII	6AX7	9A	IL	6CF6	7CM	XXV	6M7G	7R	XXXIII
5YP1	14Q	XLVIII	6AX8	9AE	XXIII	6CG6	7BK	XXV	6M8GT	8AU	—
5Z3	4C	XVIII	6AZ8	9ED	XXIII	6CG7	9AJ	XXV	6N4	7CA	III
5Z4	5L	XVIII	6B4G	5S	IL	6CG8	9GF	XXV	6N4	7CA	XXVI
5-125B	7BM	XVI	6B5	6AS	—	6CG8A	9GF	IL	6N5	6R	—
6A3	4D	—	6B6G	7V	—	6CH6	9BA	XXV	6N6G	7AU	—
6A4	5B	—	6B7	7D	—	6CH7	9EW	XXV	6N7	8B	III
6A5GT	6T	XXXII	6B8	8E	XXX	6CH8	9FT	XXV	6N7	8B	XXXI
6A6	7B	IL	6BA6	7BK	XXIII	6CJ6	9AS	XXV	6N8	9T	XXVI
6A7	7C	IL	6BA7	8CT	XXIII	6CK4	8JB	XXXII	6P5GT	6Q	—
6A8	8A	XXX	6BA8A	9DX	XXIII	6CK6	9AR	XXV	6P7G	7U	—
6AB4	5CE	XXII	6BC4	9DR	XXIII	6CL5	8GD	XXXII	6P8G	8K	XXXIII
6AB5	9R	—	6BC5	7BD	XXIII	6CL6	9BV	XXV	6Q4	9S	XXVI
6AB6G	7AU	—	6BC7	9AX	XXIII	6CL8	9FX	XXV	6Q5G	6Q	—
6AB7	8N	XXX	6BC8	9AJ	XXIII	6CL8A	9FX	IL	6Q6G	6Y	—
6AB8	9AT	XXII	6BD4	fig. 80	—	6CM6	3CK	XXV	6Q7	7V	XXXI
6AC5GT	6Q	XXXII	6BD4A	—	—	6CM7	9ES	XXV	6R4	9R	XXVI
6AC6G	7AU	—	6BD5GT	6CK	XXXII	6CM8	9FZ	XXV	6R6G	6AW	—
6AC7	8N	XXX	6BD6	7BK	XXIII	6CN7	9EN	XXV	6R7	7V	XXXI
6AD5G	6Q	—	6BD7	9Z	XXIII	6CQ6	7DB	XXV	6R8	9E	XXVI
6AD6G	7AG	—	6BE6	7CH	XXIII	6CQ8	9GE	XXVI	6S4	9AC	XXVII
6AD7G	8AY	XXXII	6BE7	9AA	XXIII	6CR6	7EA	XXVI	6S4A	9AC	IL
6AD8	9T	XXII	6BE8	9EG	XXIV	6CR8	9GJ	XXVI	6S6GT	5AK	XXXIII
6AE5G	6Q	—	6BE8A	9EG	IL	6CS5	9CK	XXVI	6S7	7R	XXXI
6AE6G	7AH	—	6BF5	7BZ	XXIV	6CS6	7CH	XXVI	6S8GT	8CB	XXXIII
6AE7GT	7AX	—	6BF6	7BT	XXIV	6CS7	9EF	XXVI	6SA7	8R	XXXI
6AE8	8DU	TL	6BG6G	5BT	XXXII	6CS8	9FZ	IL	6SB7Y	8R	XXXI
6AF4	7DK	—	6BG6GA	5BT	IL	6CU5	7CV	XXVI	6SC7	8S	XXXI
6AF4A	7DK	XXII	6BH5	9AZ	XXIV	6CU6	6AM	XXXII	6SD7GT	8N	XXXIII
6AF5G	6Q	—	6BH6	7CM	XXIV	6CU8	9GM	IL	6SE7GT	8N	—
6AF6G	7AG	—	6BH8	9DX	XXIV	6CX7	9FC	XXVI	6SF5	6AB	XXXI
6AF7G	8AG	—	6BJ5	6CH	XXIV	6CX8	9DX	XXVI	6SF7	7AZ	XXXI
6AG5	7BD	XXII	6BJ6	7CM	XXIV	6CY5	7EW	XXVI	6SG7	8BK	XXXI
6AG6G	7S	—	6BJ7	9AX	XXIV	6CY7	9EF	XXVI	6SH7	8BK	XXXI
6AG7	8Y	XII	6BJ8	9ER	XXIV	6CZ5	9HN	XXVI	6SH7L	8BK	—
6AG7	8Y	XXX	6BK5	9BQ	XXIV	6D4	5AY	XX	6SJ7	8N	XXXI
6AH4GT	8EL	XXXII	6BK6	7BT	XXIV	6D6	6F	—	6SJ7Y	8N	—
6AH5G	6AP	—	6BK7	9AJ	—	6D7	7H	—	6SK7	8N	XXXI
6AH6	7BK	XXII	6BK7A	9AJ	XXIV	6D8G	8A	—	6SL7GT	8BD	XXXIII
6AH7GT	8BE	XXXII	6BK7B	9AJ	IL	6DA4	4CG	XIX	6SN7GT	8BD	XXXIII
6AJ4	9BX	XXII	6BL7GT	8BD	XXXII	6DB5	9GR	XXVI	6SN7GTA	8BD	IL
6AJ5	7BD	XXII	6BM5	7BZ	XXIV	6DB6	7CM	XXVI	6SN7GTB	8BD	IL
6AJ7	8N	—	6BN4	7EG	XXIV	6DC6	7CM	XXVI	6SQ7	8Q	XXXI
6AJ8	9CA	XXII	6BN6	7DF	XXIV	6DE6	7CM	XXVI	6SR7	8Q	XXXI
6AK5	7BD	XXII	6BN7	9AJ	XXIV	6DE7	9HF	XXVI	6SS7	8N	XXXI
6AK6	7BK	XII	6BN8	9ER	XXIV	6DG6GT	7S	XXXII	6ST7	8Q	XXXI
6AK6	7BK	XXII	6BQ5	9CV	XXIV	6DN6	5BT	XXXII	6SU7GTY	8BD	IL
6AK7	8Y	—	6BQ6GA	6AM	IL	6DN7	8BD	XXXII	6SV7	7AZ	XXXI
6AK8	9E	XXII	6BQ6GT	6AM	XXXII	6DQ5	8JC	XXXII	6SZ7	8Q	—
6AL5	6BT	XXII	6BQ6GTB/	6CU6	IL	6DQ6	6AM	XXXII	6T4	7DK	XXVII
6AL6G	6AM	—	6BQ7	9AJ	—	6DS5	7BZ	XXVI	6T5	6R	—
6AL7GT	8CH	XXXII	6BQ7A	9AJ	XXIV	6DT5	9CV	XXVI	6T6GM	6Z	—
6AM4	9BX	XXII	6BR7	9BC	XXIV	6DT6	7EN	XXVI	6T7	7V	—
6AM5	6CH	XXII	6BR8	9FA	XXIV	6DT8	9DE	XXVI	6T8	9E	XXVII
6AM6	7DB	XXII	6BR8A	9FA	IL	6DW5	9CK	XXXIII	6T8A	9E	L
6AM8	9CY	XXII	6BS5	9BK	XXIV	6E5	6R	—	6U3	9BM	—
6AM8A	9CY	IL	6BS7	9BB	XXIV	6E6	7B	—	6U4GT	4CG	XIX
6AN4	7DK	XXII	6BS8	9AJ	XXIV	6E7	7H	—	6U5	6R	—
6AN5	7BD	XXII	6BT6	7BT	XXIV	6E8G	8O	—	6U6GT	7S	XXXIII
6AN6	7BJ	—	6BT8	9FE	XXIV	6EF6	7S	XXXIII	6U7G	7R	—
6AN7	9Q	XXII	6BU5	3FP	—	6F4	7BR	III	6U8	9AE	XXVII
6AN8	9DA	XXII	6BU6	7BT	XXIV	6F4	7BR	XXXVII	6U8A	9AE	L
6AN8-A	9DA	IL	6BU8	9FG	XXIV	6F5	5M	XXX	6V3	9BD	—
6AQ4	7DT	XXII	6BV7	9BU	XXIV	6F6	7AC	XII	6V3A	9BD	—
6AQ5	7BZ	XII	6BV8	9FJ	XXIV	6F6	7AC	XXX	6V4	9M	XIX
6AQ5	7BZ	XXII	6BW4	9DJ	XXIV	6F6G	7AC	XII	6V5GT	6AO	XXXIII
6AQ5A	7BZ	IL	6BW6	9AM	XXIV	6F7	7E	—	6V6	7AC	XXXI
6AQ6	7BT	XXIII	6BW7	9AQ	XXV	6F8G	8G	XXXIII	6V6GT	7AC	XII
6AQ7GT	8CK	XXXII	6BW8	9AQ	XXV	6G5	6R	—	6V6GTA	7S	L
6AR5	6CC	XXXIII	6BX4	5BS	XVIII	6G6G	7S	XXXIII	6V7G	7V	—
6AR6	6BQ	XXXII	6BX6	9AQ	XXV	6H4GT	5AF	—	6V8	9AH	XXVII
6AR7GT	7DE	XXXII	6BX7GT	8BD	XXXII	6H5	6R	—	6W4GT	4CG	—
6AR8	9DP	XXIII	6BY4	—	XXXVII	6H6	7Q	XXX	6W5G	6S	—
6AS5	7CV	XXIII	6BY5G	6CN	XVIII	6H8G	8E	XXXIII	6W6GT	7S	XXXIII
6AS6	7CM	XXIII	6BY6	7CH	XXV	6J4	7BQ	XXVI	6W7G	7R	—
6AS7G	8BD	XXXII	6BY7	9AQ	XXV	6J5	6Q	XXX	6X4/6063	7CF	XIX
6AS7GA	8BD	IL	6BY8	fig. 77	XXV	6J6	7BF	III	6X5GT	6S	XIX
6AS8	9DS	XXIII	6BZ6	7CM	XXV	6J6	7BF	XXVI	6X6G	7AL	XXXIII
6AT6	7BT	XXIII	6BZ7	9AJ	XXV	6J6A	7BF	IL	6X8	9AK	XXVII
6AT8	9DW	XXIII	6BZ8	9AJ	XXV	6J7	7R	XXX	6X8A	9AK	L
6AT8A	9DW	IL	6C4	6BG	III	6J8G	8H	—	6Y3G	4AC	—
6AU4GT	4CG	—	6C4	6BG	XXV	6K5GT	5U	—	6Y5	6J	—
6AU5GT	6CK	XXXII	6C5	6Q	XXX	6K6GT	7S	XXXIII	6Y6G	7S	XII
6AU6	7BK	XXIII	6C6	6F	IL	6K7	7R	XXX	6Y6G	7S	XXXIII
6AU6A	7BK	IL	6C7	7G	—	6K8	8K	XXX	6Y6GA	7S	L
6AU7	9A	IL	6C8G	8G	XXXII	6L4	7BR	XXXVII	6Y6GT	7S	L
6AU8	9DX	XXIII	6CA5	7CV	XXV	6L5G	6Q	—	6Y7G	8B	—
6AV4	5BS	XVIII	6CB5	8GD	XXXII	6L6	7AC	XIII	6Z3	4G	XIX
6AV5GA	6CK	IL	6CB5A	8GD	IL	6L6	7AC	XXX	6Z4	5D	XIX
6AV5GT	6CK	XXXII	6CB6	7CM	XXV	6L6G	7AC	XIII	6Z5	6K	—
6AV6	7BT	XXIII	6AW8A	7CM	IL	6L6GA	7S	IL	6Z7G	8B	—
6AW7GT	8CQ	—	6AW8A	7CM	IL	6L6GB	7S	IL	6ZY5G	6S	—
6AW8A	9DX	XXIII	6AW8A	7CM	IL	6L6GX	7S	—	7A4	5AS	L

Tipo	Zoccolo	Pag.	Tipo	Zoccolo	Pag.	Tipo	Zoccolo	Pag.	Tipo	Zoccolo	Pag.
7A5	6AA	XXXIV	12AV7	9A	XXVII	12SH7	8BK	L	25D8GT	8AF	LI
7A6	7AJ	L	12AW6	7CM	XXVII	12SJ7	8N	L	25DN6	5BT	LI
7A7	8V	L	12AW7	7CM	—	12SK7	8N	L	25DQ6	6AM	LI
7A8	8U	XXXIV	12AX4GT	4CG	—	12SL7GT	8BD	L	25EC6	5BT	LI
7AB7	8BO	—	12AX4GTA	4CG	—	12SN7GT	8BD	L	25F5	7CV	XXVII
7AD7	8V	XXXIV	12AX7	9A	XXVII	12SN7GTA	8BD	L	25L6GT	7S	LI
7AF7	8AC	XXXIV	12AY7	9A	XXVII	12SQ7	8Q	L	25N6G	7W	—
7AG7	8V	XXXIV	12AZ7	9A	XXVII	12SR7	8Q	L	25S	6M	—
7AH7	8V	XXXIV	12B4	9AG	XXVIII	12SW7	8Q	—	25T	3G	IV
7AJ7	8V	—	12B4A	9AG	L	12SX7	8BD	—	25W4GT	4CG	—
7AK7	8V	XXXIV	12B6M	6Y	XXXVI	12SY7	8R	XXXVI	25W6GT	7S	LI
7AU7	9A	L	12B7	8V	XXXVI	12U7	9A	XXVIII	25X6GT	7Q	—
7B4	5AC	L	12B7ML	8V	—	12V6GT	7S	—	25Y4GT	5AA	—
7B5	6AE	L	12B8GT	8T	—	12W6GT	7S	L	25Y5	6E	—
7B6	8W	L	12BA6	7BK	L	12X4	5BS	XIX	25Z3	4G	XIX
7B7	8V	XXXIV	12BA7	8CT	L	12Z3	4G	—	25Z4	5AA	—
7B8	8X	L	12BD6	7BK	L	12Z5	7L	—	25Z5	6E	XIX
7C4	4AH	—	12BE6	7CH	L	14A4	5AC	—	25Z6	7Q	XIX
7C5	6AA	L	12BF6	7BT	L	14A5	5AA	—	26	4D	—
7C6	8W	XXXIV	12BH7	9A	XXVIII	14A7	8V	L	26A6	7BK	—
7C7	8V	XXXIV	12BH7A	9A	L	14AF7	8AC	L	26A7GT	8BU	—
7D7	8AR	—	12BK5	9BQ	L	14AP1-4	12A	—	26BK6	7BT	—
7E5	8BN	XXXVII	12BK6	7BT	L	14B6	8W	L	26C6	7BT	—
7E6	8W	—	12BL6	7BK	XXVIII	14B8	8X	—	26CG6	7BK	—
7E7	8AE	XXXIV	12BN6	7DF	L	14C5	6AA	—	26D6	7CH	—
7EP4	11N	XLVIII	12BQ6GA	6AM	L	14C7	8V	—	26Z5W	9BS	—
7F7	8AC	L	12BQ6GT	6AM	L	14E6	8W	—	27	5A	—
7F8	8BW	XXXIV	12BQ6GTB	6AM	L	14E7	8AE	—	28D7	5BS	XXXVI
7G7	8V	—	12BR7	9CF	XXVIII	14F7	8AC	LI	28Z5	5AB	—
7G8	8BV	—	12BT6	7BT	L	14F8	8BW	—	30	4D	—
7GP4	14G	XLVIII	12BU6	7BT	L	14H7	8V	—	31	4D	—
7H7	8V	L	12BW4	7DJ	L	14J7	8BL	—	32	4K	—
7J7	8BL	XXXIV	12BV7	9BF	XXVIII	14N7	8AC	LI	32L7GT	8Z	—
7JP1-4-7	14R	XLVIII	12BY7	9BF	XXVIII	14Q7	8AL	LI	33	5K	—
7K7	8BF	XXXIV	12BY7A	9BF	L	14R7	8AE	—	34	4M	—
7L7	8V	XXXIV	12BZ7	9A	XXVIII	14S7	8BL	—	35/51	5E	—
7N7	8AC	L	12C5	7CV	L	14V7	8V	LI	35A5	6AA	XXXVI
7Q7	3AL	L	12C8	8E	L	14W7	8BJ	—	35B5	7BZ	XXVIII
7R7	8AE	—	12CA5	7CV	L	14X7	8BZ	LI	35C5	7CV	LI
7S7	3BL	—	12CM6	9CK	L	14Y4	5AB	—	35L6GT	7S	LI
7T7	8V	—	12CN5	7CV	XXVIII	14Z3	4G	—	35T	3G	V
7V7	8V	XXXIV	12CR6	7EA	XXVIII	15	5F	—	35TG	2D	V
7VP1	14R	XLVIII	12CS5	9CK	L	15A6	9AR	—	35W4	5BQ	XIX
7W7	3BJ	—	12CS6	7CH	L	15A8	8GS	XXXVI	35Y4	5AL	—
7X6	7AJ	—	12CT8	9DA	L	15E	ng. 51	IV	35Z3	4Z	—
7X7	3BZ	XXXIV	12CU5	7CV	L	16A5	9BL	—	35Z4GT	5AA	XIX
7Y4	5AB	—	12CU6	6AM	L	17	3G	—	35Z5G	6AD	XIX
7Z4	5AB	—	12CX6	7BK	XXVIII	17AV5GA	6CK	LI	35Z6G	7Q	—
8AU8	9DX	L	12DB5	9GR	L	17C5	7CV	LI	36	5E	—
8AW8A	9DX	L	12DE8	fig. 81	XXVIII	17DQ6A	6AM	LI	37	5A	—
8BA8A	9DX	L	12DF5	9BS	XIX	17R5	7CV	LI	38	5F	—
8BH8	9DX	L	12DF7	9A	L	17Z3	9CB	—	39/44	5F	—
8BN8	9ER	L	12DK7	9HZ	XXVIII	18	6B	—	40	4D	—
8BP4	14G	—	12DL8	9HR	XXVIII	18A5	6CK	XXXVI	40Z5GT	6AD	—
8CG7	9AJ	L	12DQ6A	6AM	L	19	6C	—	41	6B	LI
8CM7	9ES	L	12DT5	9HN	L	19AQ5	7BZ	—	42	6B	LI
8CN7	9EN	L	12DT8	9DE	L	19AU4GTA	4CG	—	43	6B	XXXVI
8CS7	9EF	L	12DV8	9HR	XXVIII	19BG6GA	5BT	LI	45	4D	—
8SN7GTB	8BD	L	12DW5	9CK	L	19C8	9E	—	45Z3	5AM	—
9AU7	9A	L	12DZ6	7BK	XXVIII	19J6	7BF	—	45Z5GT	6AD	—
9AU8A	9AE	L	12E5GT	6Q	—	19T8	9E	—	46	5C	—
9BM5	7BZ	—	12EA6	7BK	XXVIII	19V8	9AH	—	47	5B	—
9BW6	9AM	—	12EC8	9FA	XXVIII	19X3	9BM	—	48	6A	—
9NP1	6BN	—	12ED5	7CV	XXVIII	19X8	9AK	—	49	5C	—
9U8A	9AE	—	12EF6	7S	L	19Y3	9BM	—	50	4D	—
10	4D	—	12EK6	7BK	XXVIII	20	4D	—	50A5	6AA	LI
10GP4	14G	—	12EL6	7FB	XXVIII	20AP1-4	12A	—	50AX6G	7Q	—
10HP4	14G	—	12EM6	9HV	XXVIII	20J8GM	8H	—	50B5	7BZ	XXIX
10Y	4D	IV	12EN6	7S	XXXVI	21A6	9AS	—	50BK5	9BQ	LI
11/12	4F	—	12F5GT	6M	—	21A7	8AR	—	50C5	7CV	LI
12A4	9AG	XXVII	12F8	3FH	XXVIII	22	4K	—	50C6G	7S	XXXVI
12A5	7F	—	12FP7	14E	—	24A	5E	—	50C6GA	7S	LI
12A6	7S	XXXVI	12G4	5BG	L	24G	2D	IV	50L6GT	7S	LI
12A7	7K	—	12G7G	7V	XXXVI	24XH	fig. 1	XLVIII	50T	2D	—
12A8GT	8A	L	12G8	9CZ	XXVIII	25A6	7S	—	50X6	7AJ	XIX
12AB5	9EU	XXVII	12GP7	14S	—	25A7GT	8F	—	50Y6GT	7Q	XIX
12AC6	7BK	XXVII	12H4	7DW	XXVIII	25AC5GT	6Q	XXXVI	50Y7GT	8AN	XIX
12AD6	7CU	XXVII	12H6	7Q	L	25AV5GA	6CK	LI	50Z6G	7Q	XIX
12AD7	9A	XXVII	12HP7	11J	—	25AV5GT	6CK	LI	50Z7G	8AN	—
12AE6	7BT	XXVII	12J5GT	6Q	L	25AX4GT	4CG	—	51	5E	—
12AF6	7BK	XXVII	12J7GT	7R	L	25B5	6D	—	52	5C	—
12AG6	7CH	XXVII	12J8	9GC	XXVIII	25B6G	7S	—	53	7B	—
12AH7GT	8BE	XXXVI	12K5	7EK	XXVIII	25B8GT	8T	—	53A	fig. 53	—
12AH8	9BP	XXVII	12K7GT	7R	L	25BK5	9BQ	—	55	6G	—
12AJ6	7BT	XXVII	12K8	8K	L	25BQ6GA	6AM	LI	56	5A	—
12AL5	6BT	L	12L6GT	7S	XXXVI	25BQ6GT	6AM	LI	56AS	5A	—
12AL8	9GS	XXVII	12L8GT	8BU	—	25BQ6GTB	6AM	LI	57	6F	—
12AQ5	7BZ	XXVII	12Q7GT	7V	L	25C5	7CV	LI	57AS	6F	—
12AT6	7BT	L	12R5	7CV	XXVIII	25C6G	7AC	LI	58	6F	—
12AT7	9A	XXVII	12S8GT	8CB	L	25C6GA	7S	LI	58AS	6F	—
12AU6	7BK	L	12SA7	8R	L	25CA5	7CV	LI	59	7A	—
12AU7	9A	III	12SC7	8S	L	25CD6G	5BT	LI	70A7GT	8AB	—
12AU7A	9A	XXVII	12SF5	6AB	L	25CD6GA	5BT	LI	70L7GT	8AA	—
12AV5GA	6CK	L	12SF7	7AZ	L	25CD6GB	5BT	LI	71-A	4D	—
12AV6	7BT	L	12SG7	8BK	L	25CU6	6AM	LI	72	4P	—

CII

Tipo	Zoccolo	Pag.	Tipo	Zoccolo	Pag.	Tipo	Zoccolo	Pag.	Tipo	Zoccolo	Pag.
73	4Y	—	592	fig. 28	IX	991	—	XX	5693	8N	XXXI
75	6G	LI	705-A	fig. 45	—	1003	4R	—	5694	8CS	XXXIII
75TH	2D	VI	717-A	8BK	XXXIII	1005	5AQ	—	5696	7BN	XX
75TL	2D	VI	756	4D	—	1006	4C	—	5722	5CB	XXIX
76	5A	—	800	2D	—	1201	8BN	XXXVII	5725	7CM	LI
77	6F	—	801A/801	4D	IV	1203	4AH	—	5726	6BT	LI
78	6F	LI	802	6BM	XII	1204	8BO	—	5727	7BN	XX
79	6H	—	803	5J	XVI	1206	8BV	—	5731	5BC	XXXVII
80	4C	XIX	804	fig. 61	XV	1221	6F	LI	5749	7BK	LI
81	4B	—	805	3N	VIII	1223	7R	LI	5750	7CH	LI
82	4C	—	806	2N	IX	1229	4K	—	5751	9A	LI
83	4C	XIX	807	5AW	XIV	1230	4D	—	5755	9J	—
83-V	4AD	XIX	807W	5AW	XIV	1231	8V	XXXIV	5763	9K	XII
84/6Z4	5D	XIX	808	2D	—	1232	8V	—	5764	fig. 21	III
85	6G	—	809	3G	V	1265	4AJ	XX	5765	fig. 21	III
85AS	6G	—	810	2N	IX	1266	4AJ	XX	5766	fig. 21	III
89	6F	—	811	3G	V	1267	4V	XX	5767	fig. 21	III
90C1	5BO	XX	811A	3G	VI	1273	8V	XXXIV	5768	fig. 21	XXXVII
99	4D	—	812	3G	V	1274	6S	—	5794	fig. 21	—
100TH	2D	VI	812A	3G	VI	1275	4C	—	5812	7CQ	—
100TL	2D	VII	812H	3G	—	1276	4D	—	5814	9A	—
111H	2D	—	813	5BA	XVI	1280	8V	—	5814A	9A	LI
112A	4D	—	814	fig. 64	XV	1284	8V	XXXVI	5823	4CK	XX
117L7GT	8AO	XIX	815	8BY	XIII	1291	7BE	XXXV	5824	7S	XXXVI
117L7GT	8AO	XXXVI	816	4P	XIX	1293	4AA	XXXV	5825	4P	—
117M7GT	8AO	XIX	822	3N	—	1294	4AH	XXXV	5839	6S	—
117M7GT	8AO	XXXVI	822S	2N	—	1299	6BB	XXXV	5842	9V	XXIX
117N7GT	8AV	XIX	826	7BO	VI	1602	4D	—	5844	7BF	—
117N7GT	8AV	XXXVI	828	5J	XV	1603	6F	X	5845	5CA	—
117P7GT	8AV	XIX	829	7BP	—	1608	4D	IV	5847	9X	XXIX
117P7GT	8AV	LI	829A	7BP	—	1609	5B	XXXVII	5852	6S	—
117Z3	4CB	XIX	829B	7BP	XIV	1610	fig. 62	XII	5857	9AB	—
117Z4GT	5AA	—	830	4D	—	1611	7S	—	5866	fig. 3	VIII
117Z6GT	7Q	—	830B	3G	VI	1612	7T	XXXI	5867	fig. 3	X
128AS	5A	—	831	fig. 40	—	1613	7S	XII	5871	7AC	LI
150T	2N	—	832	7BP	XIII	1614	7AC	XIII	5876	fig. 21	III
152TH	4BC	VIII	832A	7BP	XIII	1616	4P	—	5879	9AD	XXIX
152TL	4BC	VIII	833A	fig. 41	XI	1619	fig. 74	XIII	5881	7AC	XIII
182-B	4D	—	834	2D	—	1620	7R	XXXI	5890	12J	XX
183	4D	—	835	4E	—	1621	7S	XXXI	5893	fig. 21	III
203-A	4E	VII	836	4P	XIX	1622	7AC	XXXI	5894A	fig. 7	XIV
203-H	3N	—	837	6BM	XII	1623	3G	V	5910	6AR	LI
204-A	fig. 39	—	838	4E	VII	1624	fig. 66	XIII	5915	7CH	LI
205-D	4D	—	840	5J	—	1625	5AZ	XIV	5920	7BF	—
211	4E	—	841	4D	—	1626	6Q	—	5933	5AZ	XIV
212-E	fig. 43	—	841A	3G	—	1627	2N	—	5961	8R	XXXI
217-A	4AT	—	841SW	3G	—	1628	fig. 54	—	5962	2AG	XX
217-C	4AT	—	843	5A	—	1629	6RA	—	5963	9A	LI
227-A	4AT	—	844	5AW	—	1631	7AC	LI	5964	7BF	LI
241-B	fig. 53	—	849	fig. 39	—	1632	7S	LI	5965	9A	LI
242-A	fig. 44	—	850	fig. 47	—	1633	8BD	—	5993	fig. 35	—
242-B	4E	—	852	2D	—	1634	8S	LI	5998	8BD	XX
242-C	4E	—	860	fig. 58	—	1635	8B	XXXIII	6001	7BM	—
249-B	fig. 29	—	861	fig. 42	—	1641	fig. 52	—	6005	7BZ	—
250TH	2N	IX	864	4D	—	1642	7BH	—	6023	9CD	—
250TL	2N	IX	865	fig. 57	—	1644	fig. 4	—	6026	fig. 16	III
254	2N	VII	866	4P	—	1654	2Z	—	6028	7BD	XXIX
254-A	fig. 57	—	866A-AX	4P	XIX	1802P1-11	11A	XIVVII	6045	7AC	XXIX
254-B	fig. 57	—	866B	4P	XIX	1805P1-4	11A	XLVII	6046	7BF	LI
261-A	4E	—	866jr	4B	XIX	1806P1	11N	XLVII	6057	9A	LI
270-A	fig. 39	—	871	4P	—	1851	7R	—	6058	6BT	LI
276-A	4E	—	872A 872	4AT	XIX	1852	8N	XXX	6059	9BC	LI
282-A	fig. 57	—	872A	4AT	—	1853	3N	XXX	6060	9A	LI
284-B	3N	—	874	4S	—	2001	4AA	XLVIII	6061	9AM	LI
284-D	4E	—	878	4P	—	2002	fig. 1	XLVIII	6062	9BK	—
295-A	4E	—	879	4AB	—	2005	fig. 1	XLVIII	6063	7CF	XIX
300T	2N	—	884	6Q	XX	2050	8BA	XX	6064	7DB	LI
303-A	4E	VII	885	5A	—	2051	8BA	—	6065	7DB	LI
304-A	fig. 39	—	902A	8CD	XLVIII	2523N/	—	—	6066	7BT	LI
304-B	2D	—	905	5BP	XLVIII	128A	5A	—	6067	9A	LI
304TH	4BC	X	905A	5BR	XLVIII	5514	4BO	VI	6072	9A	—
304TL	4BC	X	906P1-11	7AN	XLVII	5516	7CL	XIII	6073	5BO	XX
305-A	fig. 59	—	907	5BP	XLVIII	5517	5BU	—	6074	5BO	XX
306-A	fig. 63	—	908A	7CE	XLVIII	5556	4D	III	6080	8BD	LI
307-A	fig. 61	—	909	5BP	—	5562	fig. 30	—	6082	8BD	XXXVI
308-B	fig. 43	—	910	7AN	—	5590	7BD	XXIX	6084	9BJ	—
310	4D	—	911	7AN	—	5591	7BD	LI	6085	9A	—
311	4E	—	912	912	XLVIII	5608	7BD	XXIX	6086	9BK	—
311CH	fig. 32	—	913	913	XLVIII	5608A	7B	—	6087	5L	—
312-A	fig. 68	—	914A	6BF	—	5610	6CG	XXIX	6101	7BF	LI
312-E	fig. 44	—	930B	3G	VI	5618	7CU	XII	6132	9BA	LI
316-A	—	V	938	4E	VII	5651	5BO	XX	6135	6BG	—
327-A	fig. 50	—	950	5K	—	5654	7BD	LI	6136	7BK	LI
327-B	fig. 50	—	951	4M	—	5656	9F	XXIX	6137	8N	XXXI
342-B	4E	—	954	5BB	XXXVII	5662	fig. 79	XX	6140	9BY	—
356-A	fig. 55	—	955	5BC	XXXVII	5663	7CE	XX	6141	9BZ	—
361-A	4E	—	955	5BC	III	5670	8CJ	LI	6146	7CK	XIV
376-A	4E	—	956	5BB	XXXVII	5675	fig. 21	III	6155	5BK	XVI
417-A	9V	LI	957	5BD	—	5679	7CX	LI	6156	5BK	XVI
482-B	4D	—	958	5BD	—	5686	9G	XII	6157	fig. 36	—
483	4D	—	958A	5BD	III	5686	9G	XXIX	6158	9A	—
485	5A	—	958A	5BD	XXXVII	5687	9H	XXIX	6159	7CK	XIV
527	fig. 53	—	959	5BE	XXXVII	5690	fig. 38	—	6173	fig. 34	XXXVII
559	fig. 10	—	967	3G	XX	5691	8BD	LI	6197	9BV	—
575-A	4AT	—	975A	4AT	—	5692	8BD	LI	6201	9A	LI

Tipo	Zoccolo	Pag.	Tipo	Zoccolo	Pag.	Tipo	Zoccolo	Pag.	Tipo	Zoccolo	Pag.
6211	9A	—	AX9905	fig. 20	XIII	HV18	2N	VIII	RK43	.6C	—
6216	fig. 37	XXIX	AX9910	fig. 7	XIII	HV27	3N	—	RK44	.6BM	—
6218	9CG	—	BA	4J	—	HY6J5GTX6Q	—	—	RK46	fig. 61	—
6227	9BA	XXIX	BH	4J	—	HY6L6GTX7AC	—	—	RK47	fig. 64	—
6252	fig. 7	XIII	BR	4H	—	HY24	4D	—	RK48	fig. 64	—
6263	—	IV	CE220	4P	—	HY25	3G	—	RK48A	fig. 64	—
6264	—	IV	CK1005	5AQ	—	HY30Z	4BO	—	RK49	.6A	—
6265	7CM	LI	CK1006	4C	—	HY31Z	fig. 60	V	RK51	.3G	—
6287	9CT	XXIX	CK1007	fig. 73	—	HY40	3G	—	RK52	.3G	—
6299	—	XXXVII	DR3B27	4P	—	HY40Z	3G	—	RK56	.5AW	—
6308	8EX	XX	DR123C	fig. 15	—	HY51A	3G	—	RK57	.3N	—
6350	9CZ	LI	DR200	2N	VIII	HY51B	3G	—	RK58	.3N	—
6354	fig. 12	XX	EEC81	9A	LII	HY51Z	4BO	—	RK59	fig. 60	—
6360	fig. 13	XIII	EEC82	9A	LII	HY57	3G	—	RK61	—	XX
6374	9BW	—	EEC83	9A	LII	HY60	.5AW	—	RK62	.4D	—
6386	8CJ	XXIX	EF50	9C	—	HY61	.5AW	—	RK63	.2N	—
6417	9K	XII	F123A	fig. 15	—	HY63	fig. 72	—	RK63A	.2N	—
6443	9BW	—	F127A	fig. 15	—	HY65	fig. 72	—	RK64	.5AW	—
6485	7BK	LI	G84	4B	XVIII	HY67	fig. 65	—	RK65	fig. 48	—
6524	fig. 76	XIV	GL2C39A	—	VII	HY69	fig. 64	—	RK66	fig. 61	—
6660	7CC	LI	GL2C39B	—	VII	HY75	2T	—	RK75	fig. 61	—
6661	7CM	LI	GL2C44	fig. 9	—	HY75A	2T	IV	RK100	fig. 67	—
6662	7CM	LI	GL5C24	fig. 15	IX	HY114B	2T	III	RK705A	fig. 45	—
6663	6BT	LI	GL146	fig. 56	VIII	HY615	fig. 71	III	RK866	.4P	—
6669	7BZ	LI	GL152	fig. 56	VIII	HY801A	4D	—	T20	.2G	IV
6677	9BV	LI	GL159	fig. 56	X	HY866jr	4P	—	T21	.5A	—
6678	9AE	LI	GL169	fig. 56	X	HY1231Z	fig. 60	V	T40	.3G	V
6679	9A	LI	GL446A	fig. 11	—	HY1269	fig. 65	XIV	T55	.3G	V
6680	9A	LII	GL446B	fig. 11	—	HYE1148	fig. 71	III	T60	.2D	VI
6681	9A	LII	GL464A	fig. 9	—	KT66	.7AC	LII	T100	.2D	—
6816	fig. 77	XVI	GL559	fig. 10	—	KY21	—	XX	T125	.2N	—
6829	9A	LII	GL6442	—	III	NU2C35	fig. 23	—	T200	.2N	IX
6850	fig. 76	—	GL6463	.9CZ	—	PE340	.5BK	—	T300	—	IX
6883	7CK	XIV	GL8912A	fig. 54	V	PL172	—	XVII	T814	.3N	—
6884	fig. 77	XVI	HD203A	.3N	—	PL6549	fig. 14	XV	T822	.3N	—
6887	6BT	XXIX	HF60	.2D	VI	PL6569	fig. 3	X	TB35	fig. 30	—
6893	7CK	XIII	HF75	.2D	VI	PL6580	.5BK	XI	TUF20	.2T	—
6897	—	LII	HF100	.2D	—	RK10	.4D	—	TW75	.2D	—
6939	fig. 13	XII	HF120	.4F	VII	RK11	.3G	—	TW150	.2N	—
7000	7R	LII	HF125	—	VII	RK12	.3G	—	TZ20	.3G	IV
7025	8HY	XXXIII	HF130	—	VII	RK15	.4D	—	TZ40	.3G	V
7034	fig. 75	XVII	HF140	.4F	VII	RK16	.5A	—	UE100	.2D	—
7035	fig. 75	XVII	HF150	—	VII	RK17	.5F	—	UE468	fig. 32	—
7077	—	XXXVII	HF175	fig. 46	—	RK18	.3G	—	UH35	.3G	—
7094	fig. 82	XVI	HF200	.2N	VIII	RK19	.5AT	—	UH50	.2D	—
7137	7BQ	LII	HF201-A	fig. 15	VIII	RK20	fig. 61	—	UH51	.2D	—
7700	6F	LII	HF250	.2N	VIII	RK20A	fig. 61	—	V70	.3N	—
8000	2N	IX	HF300	.2N	IX	RK21	.4P	—	V70A	.3N	—
8001	7BM	XV	HK24	.3G	IV	RK22	fig. 52	—	V70B	.3G	—
8003	3N	VII	HK54	.2D	V	RK23	.6BM	—	V70C	.3G	—
8005	3G	VI	HK57	fig. 33	XIV	RK24	.4D	—	V70D	.3G	—
8008	fig. 8	—	HK154	.2D	—	RK25	.6BM	XII	VR75	.4AJ	XX
8012	fig. 54	V	HK158	.2D	V	RK25B	.6BM	—	VR90	.4AJ	XX
8013-A	4P	—	HK252L	.4BC	VIII	RK28	.5J	—	VR105	.4AJ	XX
8016	3C	—	HK253	.4AT	—	RK28A	.5J	—	VR150	.4AJ	XX
8020	4P	—	HK254	.2N	VII	RK30	.2D	—	VT52	.4D	—
8025	4AQ	V	HK257	.7BM	XV	RK31	.3G	—	VT127A	fig. 53	VII
9001	7BD	XXIX	HK257B	.7BM	XV	RK32	.2D	—	VT191	—	V
9002	7BS	III	HK304L	.4BC	—	RK33	fig. 69	—	WE304A	.2D	—
9002	7BS	XXIX	HK354	.2N	VIII	RK34	fig. 70	IV	X6030	fig. 2	—
9003	7BD	XXIX	HK354C	.2N	VIII	RK35	.2D	—	XXB	fig. 6	—
9004	4BJ	XXXVII	HK354D	.2N	VIII	RK36	.2D	—	XXD	.8AC	LII
9005	5BG	XXXVII	HK354E	.2N	VIII	RK37	.2D	—	XXL	.5AC	XXXIV
9006	6BH	XXIX	HK354F	.2N	VIII	RK38	.2D	—	XXFM	.6BZ	—
AT340	5BK	—	HK454H	.2N	X	RK39	.5AW	—	Z225	.4P	—
AX9900	fig. 3	VIII	HK454L	.2N	X	RK41	.5AW	—	ZB60	.2D	—
AX9901	fig. 3	X	HK654	.2N	X	RK42	.4D	—	ZB120	.4E	—
AX9903	fig. 7	XIV	HV12	.3N	—						

Tipo	Pag.	Tipo	Pag.	Tipo	Pag.	Tipo	Pag.	Tipo	Pag.	Tipo	Pag.
1N21B	XXXVIII	1N55A	XXXVIII	1N70A	XXXVIII	1N112	XXXIX	1N153	XXXIX	1N751A	XL
1N23B	XXXVIII	1N55B	XXXVIII	1N77A	XXXVIII	1N113	XXXIX	1N158	XXXIX	1N758A	XL
1N26	XXXVIII	1N56	XXXVIII	1N87A	XXXIX	1N114	XXXIX	1N172	XXXIX	2N32	XLI
1N34	XXXVIII	1N56A	XXXVIII	1N88	XXXIX	1N115	XXXIX	1N175	XL	2N33	XLI
1N34A	XXXVIII	1N57	XXXVIII	1N89	XXXIX	1N116	XXXIX	1N191	XL	2N34	XLI
1N38	XXXVIII	1N58	XXXVIII	1N90	XXXIX	1N117	XXXIX	1N192	XL	2N35	XLI
1N38A	XXXVIII	1N58A	XXXVIII	1N91	XXXIX	1N118	XXXIX	1N198	XL	2N36	XLI
1N39	XXXVIII	1N59	XXXVIII	1N92	XXXIX	1N120	XXXIX	1N198A	XL	2N37	XLI
1N39A	XXXVIII	1N60	XXXVIII	1N93	XXXIX	1N126	XXXIX	1N279	XL	2N38	XLI
1N43	XXXVIII	1N60A	XXXVIII	1N94	XXXIX	1N126A	XXXIX	1N283	XL	2N38A	XLI
1N44	XXXVIII	1N61	XXXVIII	1N95	XXXIX	1N127	XXXIX	1N285	XL	2N39	XLI
1N45	XXXVIII	1N62	XXXVIII	1N96	XXXIX	1N127A	XXXIX	1N287	XL	2N40	XLI
1N46	XXXVIII	1N62	XXXVIII	1N97	XXXIX	1N128	XXXIX	1N288	XL	2N42	XLI
1N47	XXXVIII	1N63	XXXVIII	1N98	XXXIX	1N132	XXXIX	1N289	XL	2N43	XLI
1N48	XXXVIII	1N64	XXXVIII	1N99	XXXIX	1N133	XXXIX	1N290	XL	2N43A	XLI
1N49	XXXVIII	1N64A	XXXVIII	1N100	XXXIX	1N139	XXXIX	1N291	XL	2N44	XLI
1N50	XXXVIII	1N65	XXXVIII	1N105	XXXIX	1N140	XXXIX	1N292	XL	2N45	XLI
1N51	XXXVIII	1N66	XXXVIII	1N106	XXXIX	1N141	XXXIX	1N295	XL	2N47	XLI
1N52	XXXVIII	1N67	XXXVIII	1N107	XXXIX	1N142	XXXIX	1N335	XL	2N49	XLI
1N52A	XXXVIII	1N67A	XXXVIII	1N108	XXXIX	1N143	XXXIX	1N448	XL	2N63	XLI
1N54	XXXVIII	1N68	XXXVIII	1N109	XXXIX	1N147	XXXIX	1N634	XL	2N64	XLI
1N54A	XXXVIII	1N68A	XXXVIII	1N110	XXXIX	1N151	XXXIX	1N636	XL	2N65	XLI
1N55	XXXVIII	1N69A	XXXVIII	1N111	XXXIX	1N152	XXXIX	1N747A	XL	2N68	XLI

CIV

Tipo	Pag.	Tipo	Pag.	Tipo	Pag.	Tipo	Pag.	Tipo	Pag.
2N76	. XLI	2N116	. XLII	2N175	. XLIII	2N247	. XLIV	3N37	. XLV
2N77	. XLI	2N123	. XLII	2N186	. XLIII	2N255	. XLIV	AO-1	. XLV
2N78	. XLI	2N130	. XLII	2N186A	. XLIII	2N256	. XLIV	CK716	. XLV
2N81	. XLI	2N131A	. XLII	2N187A	. XLIII	2N270	. XLIV	CK721	. XLV
2N83	. XLI	2N132	. XLII	2N188	. XLIII	2N274	. XLIV	CK722	. XLV
2N84	. XLII	2N132A	. XLII	2N188A	. XLIII	2N277	. XLIV	CK723	. XLV
2N85	. XLII	2N133	. XLII	2N189	. XLIII	2N278	. XLIV	CK725	. XLV
2N86	. XLII	2N133A	. XLII	2N190	. XLIII	2N301	. XLIV	CK727	. XLV
2N87	. XLII	2N135	. XLII	2N191	. XLIII	2N301A	. XLIV	CK760	. XLV
2N91	. XLII	2N136	. XLII	2N192	. XLIII	2N370	. XLIV	CK761	. XLV
2N92	. XLII	2N137	. XLIII	2N193	. XLIII	2N384	. XLIV	CK762	. XLV
2N94A	. XLII	2N138	. XLIII	2N194	. XLIII	2N412	. XLIV	CK768	. XLV
2N104	. XLII	2N139	. XLIII	2N200	. XLIII	2N413	. XLIV	CQ1	. XLV
2N105	. XLII	2N140	. XLIII	2N206	. XLIV	2N414	. XLIV	G11	. XLV
2N106	. XLII	2N141	. XLIII	2N211	. XLIV	2N416	. XLIV	G11A	. XLV
2N107	. XLII	2N143	. XLIII	2N212	. XLIV	2N417	. XLIV	GT14	. XLV
2N108	. XLII	2N155	. XLIII	2N222	. XLIV	2N428	. XLIV	GT20	. XLV
2N109	. XLII	2N167	. XLIII	2N223	. XLIV	2N499	. XLIV	GT34	. XLV
2N112	. XLII	2N168A	. XLIII	2N224	. XLIV	2N588	. XLV	GT81	. XLV
2N113	. XLII	2N169A	. XLIII	2N226	. XLIV	3N25	. XLV	GT83	. XLV
2N114	. XLII	2N170	. XLIII	2N241A	. XLIV	3N36	. XLV	GT87	. XLV
								HA-1-8	. XLV
								HA2-9	. XLV
								HA-3-10	. XLVI
								HF1	. XLVI
								H-5	. XLVI
								IF-1	. XLVI
								J-1	. XLVI
								JP1	. XLVI
								PT2A	. XLVI
								OC70	. XLVI
								OC71	. XLVI
								OC72	. XLVI
								SB100	. XLVI
								X22	. XLVI
								X23	. XLVI
								ZJ-13	. XLVI